



EXCALIBUR WATER SYSTEMS

COMMERCIAL WATER SOFTENER

SYSTEM DESIGN DATA & SPECIFICATIONS

Model: EWS S12560

Water Softener 1.25" Simplex 60,000 Capacity

Water Softener Operating Parameters

Minimum Flow Rate, gpm	: 1.6
Critical Flow Rate, gpm	: 6.5
Service Flow Rate, gpm	: 9.5
Flow Rate 15psi ΔP, gpm	: 23.0
Flow Rate 25psi ΔP, gpm	: 31.0
Backwash Flow Rate, gpm	: 3.2
Capacity @15lbs/ft ³ , kgr	: 60.0
Capacity @10lbs/ft ³ , kgr	: 54.0
Capacity @6lbs/ft ³ , kgr	: 40.0
Capacity Max System, kgr	: 60.0
Salt Usage @ 15lbs/ft ³ , lbs	: 30.0
Salt Usage @ 10lbs/ft ³ , lbs	: 20.0
Salt Usage @ 6lbs/ft ³ , lbs	: 12.0
Resin Qty, ft ³	: 2.0
#20 Gravel Qty, lbs	: 20.0
Distributor Size, in	: 1.32
Drain Line Size, in	: 0.75
Brine Line Size, in	: 0.375

Miscellaneous Design Data

Mineral Tank Size, in.	: 12x52
Freeboard, in.	: 15.0
Bed Depth, in	: 30.5
Brine Tank Size, in.	: 18x40
Max. Salt Load, lbs.	: 450 (Dry)
Total Regeneration Time, min.	: 93
Operating Pressure, psi	: 40-110
Operating Temperature, ° F	: 40-110
Shipping Weight, lbs.	: 180
Operating Weight, lbs.	: 820
Space Req'd in, L x W x H	: 43x28x68

Electrical Specifications

Supply Voltage	: 120VAC
Supply Frequency	: 60 Hz
Output Voltage	: 15VDC
Output Current:	: 500 mA

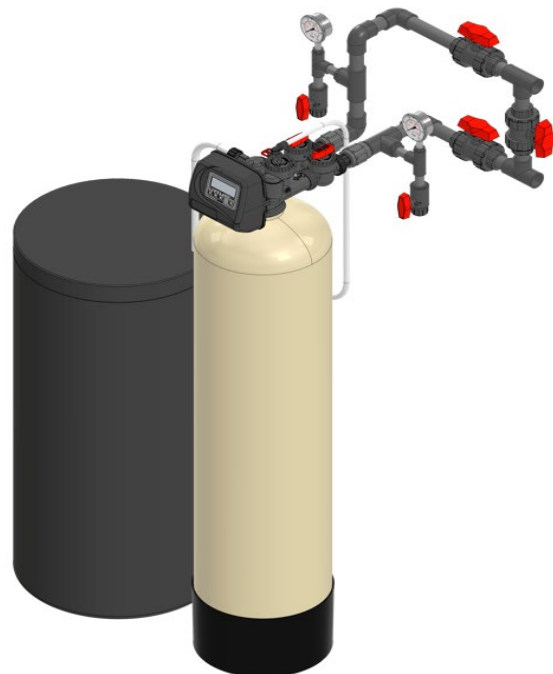
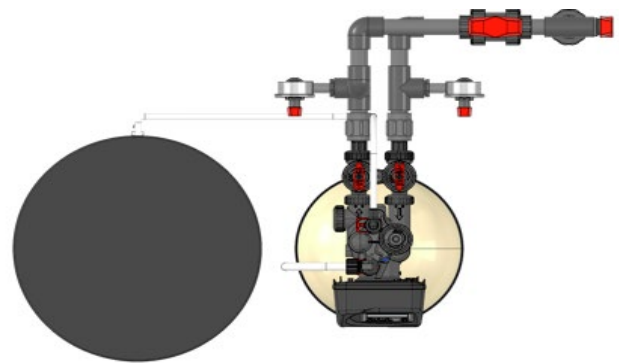

** Pipe and fittings shown not in scope*

