



Quality through innovation

1" SIMPLEX IRON SULPHUR MANGANESE INSTALLATION AND USER GUIDE

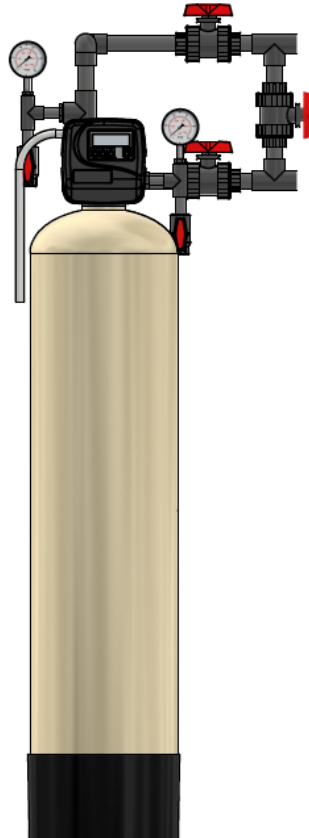

TABLE OF CONTENTS

- 1) Installation 2
 - 1.1) Pre-installation instructions..... 2
 - 1.2) General Installation and Service Warnings..... 2
 - 1.3) Site Requirements..... 2
 - 1.4) Installation Drawing..... 3
 - 1.5) Piping and Instrumentation Drawing..... 4
 - 1.6) System Drawing 5
 - 1.7) Plumbing 5
 - 1.8) Drain Line..... 5
 - 1.9) Bypass Valve..... 6
 - 1.10) Loading Instructions..... 7
 - 1.11) Start Up Instructions 8
- 2) Control Valve Programming..... 9
 - 2.1) Regeneration and Error Screens 9
 - 2.2) Button Operation 9
 - 2.3) User Displays..... 10
 - 2.4) Setting Time of Day..... 11
 - 2.5) Configuration Settings 11
 - 2.6) Installer Display Settings..... 12
 - 2.7) OEM Filter System Setup 13
 - 2.1) Diagnostics 14
 - 2.2) Programming Summary 16
- 3) Control Valve..... 17
 - 3.1) Valve Specifications 17
 - 3.2) Control Valve Functions and Cycles 20
 - 3.3) Components of Control Valve 22
- 4) Quick Reference Guide 31
- 5) Service Instructions..... 32
 - 5.1) Front Cover Removal 32
 - 5.2) PC Board Removal..... 33
 - 5.3) Drive Bracket Removal..... 34
 - 5.4) Drive Cap Removal..... 35
 - 5.5) Piston Removal 36
 - 5.6) Stack Assembly Removal..... 37
- 6) Troubleshooting..... 38
 - 6.1) Possible Error Codes 38
 - 6.2) Troubleshooting Procedures..... 39
- 7) 5 Year Warranty 43

1) INSTALLATION

1.1) Pre-installation instructions

The cycle times, sequence of cycles and filtration capacity are preset to default by OEM. The dealer must guide the installer to change the values according to the water quality, day override and time of regeneration.

WATER TEST

Hardness	_____	gpg
Iron	_____	ppm
pH	_____	number
*Nitrates	_____	ppm
Manganese	_____	ppm
Sulphur	_____	yes/no
Total Dissolved Solids	_____	

1.2) General Installation and Service Warnings

- The filter is designed so that it can be installed easily with minor plumbing changes on previous plumbing.
- The piping must be clamped properly and the weight of the plumbing must not be on the Filter.
- Do not use any kind of lubricant including silicone. A silicone based lubricant can be only used on O- Rings but not necessary.
- The nuts and caps can be fastened and unfastened by hand or the plastic service wrench. Do not use pipe wrench to tighten the caps and nuts.

1.3) Site Requirements

- Water Pressure: - 40-110 psi
- Water Temperature: - 40-110°F (4.4-43°C)
- Electrical- 115/120 V, 60Hz Uninterrupted Outlet
- Current required is 0.5 Amperes
- The plug-in transformer is for dry locations only
- The tank should be on a firm level surface

1.4) Installation Drawing

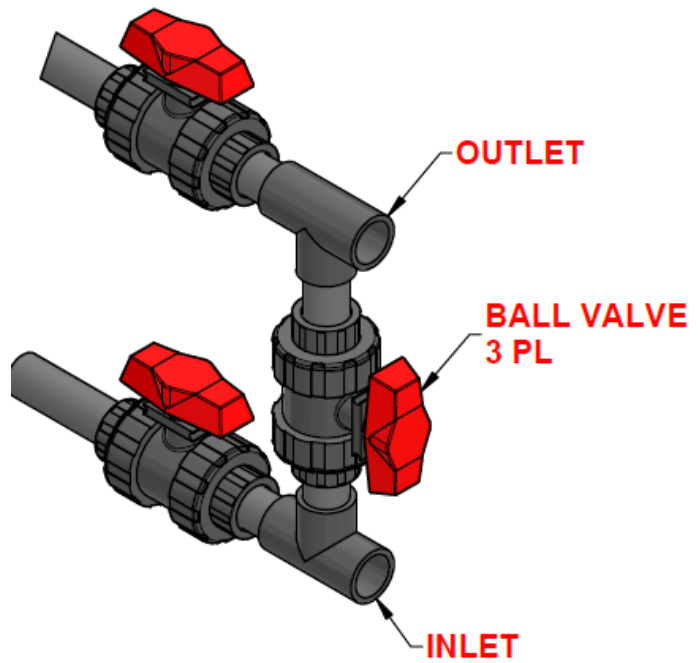
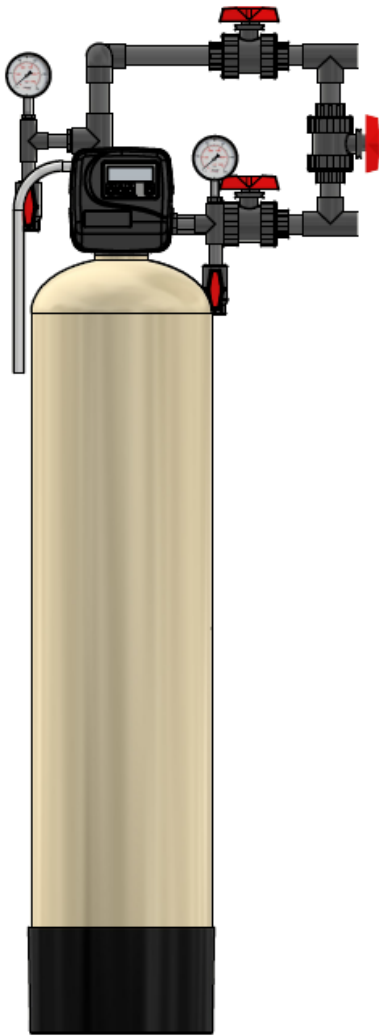
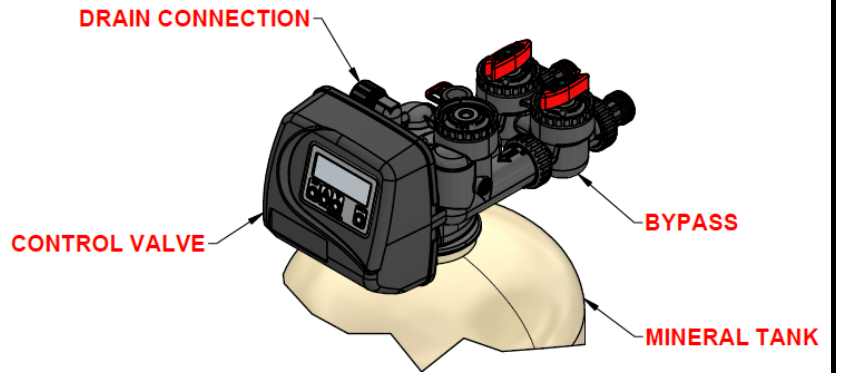
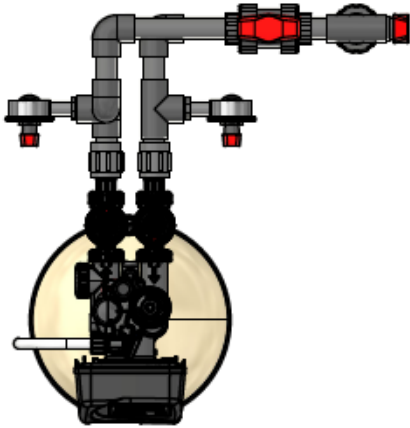

1.5) Piping and Instrumentation Drawing

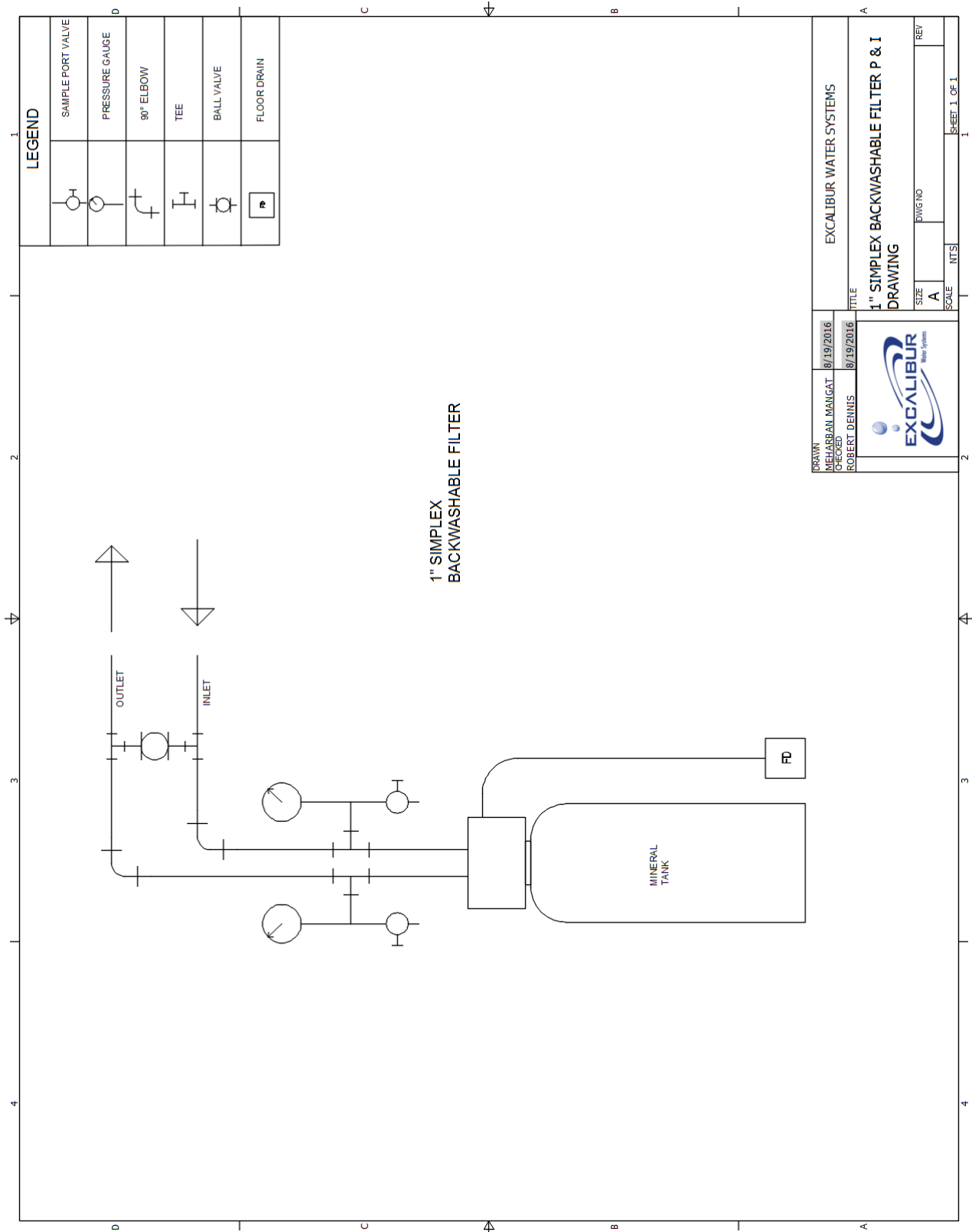

1.6) System Drawing

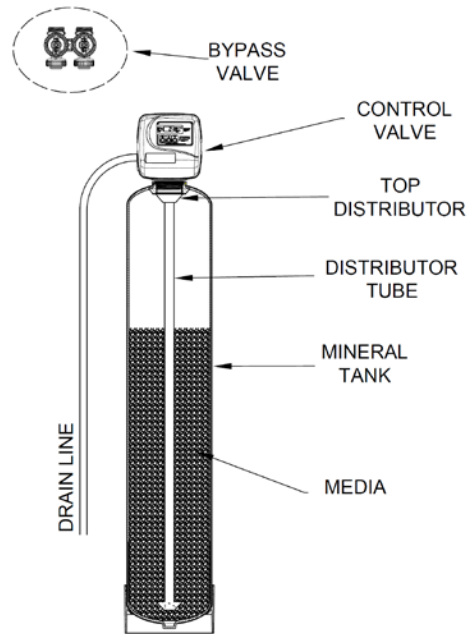

1.7) Plumbing

- The system must be close to drain as much as possible.
- The unit including the drain must be located in a room temperature above 33° F.
- The bypass valves must be installed on the control valves.
- The primer, solder or solder flux must not get on the O-rings.
- After soldering the lines must be cooled before installing the O-Rings, nuts and caps.
- If the electrical system is grounded to the plumbing than copper strap must be connected between inlet and outlet as shown in figure above.
- The plumbing must be done by following the local plumbing codes.
- Never let the vacuum occur in tank this may cause implosion and leakage. If vacuum occurrence
Overflow Line Connection

1.8) Drain Line

- The size of the drain must be according to the specifications.
- Leave minimum of 6" gap between flow control fitting and solder joints. The gap less than this can damage the flow control.
- Use ¾" or 1" tubing for drain line according to the specifications.
- If the drain line is elevated and then emptied into the drain below the level the of control valve the 7" loop should make at the end of drain line.
- The air gap between the drain and the end of the drain line must be twice the diameter of the tube.
- The strap must be tied at the end to secure the line.

1.9) Bypass Valve

NORMAL OPERATION

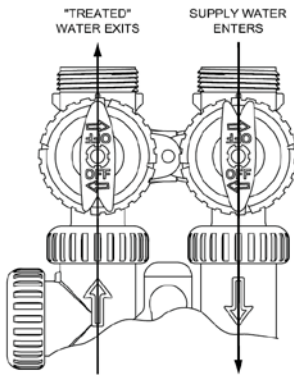

NORMAL OPERATION

The inlet and outlet handles point in the direction of flow indicated by the engraved arrows on the control valve. Water flows through the control valve for normal operation as a water Filter.

BYPASS OPERATION

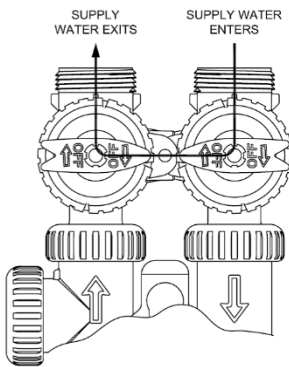

BYPASS OPERATION

The inlet and outlet handles point to the center of the bypass. The system is isolated from the water pressure in the plumbing system. Unfiltered water is supplied to the building.

DIAGNOSTIC MODE

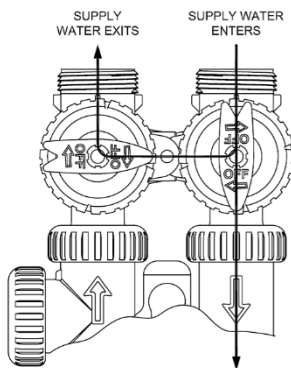

DIAGNOSTIC MODE

The inlet handle points in the direction of flow and the outlet handle points to the center of bypass valve, system water pressure is allowed to the control valve and the plumbing system while not allowing water to exit from the control valve to the plumbing.

SHUT OFF MODE

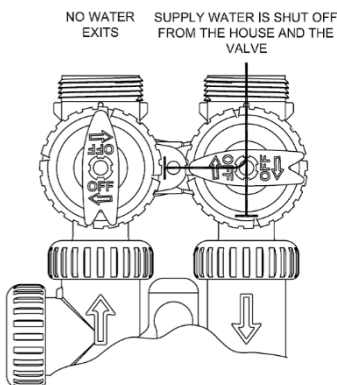

SHUT OFF MODE

The inlet handle points to the center of the bypass valve and the outlet handle points in the direction of flow, the water is shut off to the plumbing system. If water is available on the outlet side of the Filter it is an indication of water bypass around the system (i.e. a plumbing connection somewhere in the building bypasses the system).

1.10) Loading Instructions

Step 1: Check the product upon removal and remove from box packaging checking for any shipping damage or shortages that must be reported to Excalibur Water Systems immediately for confirmation.

Step 2: Insert distributor(s) inside of media mineral tank(s) so it is positioned properly in the bottom centre groove. If not already sized properly cut the top of the distributor pipe $\frac{1}{2}$ - $\frac{3}{4}$ " above top of tank opening and clean off and excess PVC materials with grit cloth.

Step 3: Plug the top inlet opening of the distributor (Hub & Lateral) or bottom stack with a clean cloth, rag, or tape to prevent any gravel or resin from entering into the distributor tube.

Step 4: Load the gravel under bedding onto the mineral tank using a funnel or some sort of loading device. If multiple layers of gravel with different sizes being utilized always load the largest gravel size in diameter to the smallest last.

Step 5: Load the media also by the use of a funnel or some sort of loading device until all resin is inside of mineral tank. If loading a duplex system that has two tanks divide the resin and gravel up equally when loading.

Step 6: Remove top opening cover of the distributor carefully not to move or disturb the distributor tube not allowing any debris or materials to get inside of the now loaded Filter(s).

Step 7: Thread on control valves onto top opening tanks be sure to check and verify that the O-ring on the bottom base of the control valve is present and properly lubricated with silicone. Tighten control valve(s) clockwise until you have reached the end of the thread and have secured a water tight seal. (If control valves that utilize quick connect collars thread the collars the same into the tanks then attach control valves).

Step 8: Precede now with the unit(s) in their proper installation locations to run piping and materials for all inlet, outlet, and drain connections properly with isolation valves and test ports for future water tests. Also unions should be included in installation materials for easy future servicing of the control valves when necessary on all inlet, outlet, and drain lines.

1.11) Start Up Instructions

- Keep the bypass valve in bypass operation by moving both the handles into the center direction of the bypass valve. Now the unfiltered water is being supplied to house. Open the faucet until water comes clear out of it. The initial water can be dirty because of installation debris. Now inspect the leaks in plumbing.
- Press and hold the “REGEN” button down for 5 seconds to start manual regeneration. The drive motor will start the backwash cycle and countdown time begins. Turn the inlet bypass valve handles halfway into the direction of service operation. Once the steady water flows out of drain then fully open the bypass valve into the direction of service operation.
- Press REGEN button to advance the regeneration to rinse cycle. The water will come through the drain. Allow this process until water coming through the drain becomes clear.

2) CONTROL VALVE PROGRAMMING

2.1) Regeneration and Error Screens



Regen Screen

Displays the time remaining in the current cycle. Pressing REGEN advances to the next cycle.

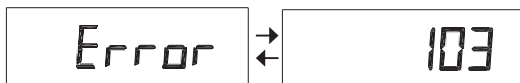

Error Screen

Alternated flashing Error and error code every 3 seconds. Clear by disconnecting the power supply at the PC board and reconnecting, or press NEXT and REGEN simultaneously for 3 seconds.

2.2) Button Operation



Scrolls to the next display.



- Pressing once and releasing will schedule a regeneration at the preset delayed regeneration time.
- Pressing again and releasing will cancel the regeneration.
- Pressing and holding for 3 seconds will initiate an immediate regeneration
- Pressing while in regeneration will advance to the next cycle.
- Pressing in the program levels will go backwards to the previous screen



Change Variable being displayed.



Key sequence to lock and unlock program settings



Holding for 3 seconds initiates a control reset. The software version is displayed and the piston returns to the home/service position, resynchronizing the valve.

2.3) User Displays

When the system is operating, one of five displays may be shown. Pressing NEXT will alternate between the displays shown below.

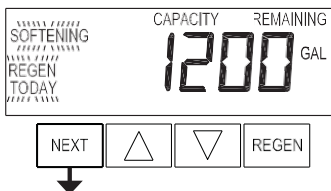

User 1

Typical user display. Shows volume remaining to regeneration. This screen will not be viewed if the control is set for time-clock operation.

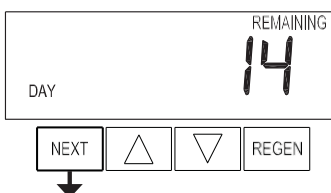

User 2

Displays number of days to next regeneration.

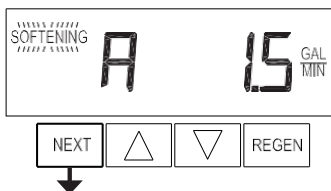

User 3

Flow Rate.
Displays present flow rate.

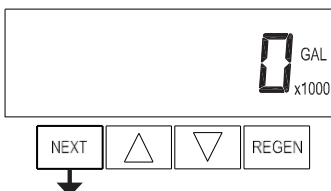

User 4

Displays total volume in gallons since last reset. If a meter is not used this display will be shown but 0 will be displayed.
PRESS ▼ FOR 3 SECONDS TO RESET TO 0.



User 5

Shows current time.

2.4) Setting Time of Day

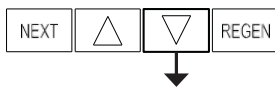

Push NEXT until time of day screen is displayed. Press and hold ▼ until SET TIME is displayed and the hour flashes once. Press ▲ or ▼ until the correct hour is displayed.



Then press NEXT. The minutes will flash. Press ▲ or ▼ until the correct minute is displayed.

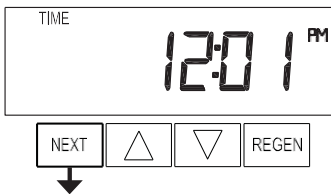

Press NEXT to return to the User Displays. Time of day should only need to be set after power outages lasting more than 8 hours, if the battery has been depleted and a power outage occurs, or when daylight saving time begins or ends. If a power outage lasting more than 8 hours occurs, the time of day will flash on and off which indicates the time of day should be reset. If a power outage lasts less than 8 hours and the time of day flashes on and off, the time of day should be reset and the battery replaced.

2.5) Configuration Settings

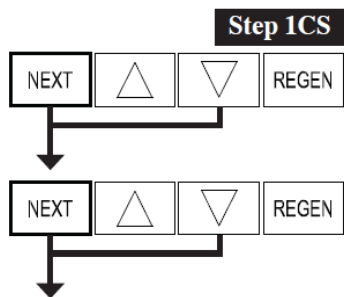

Step 1CS

Step 1CS – Press NEXT and ▼ simultaneously for 5 seconds and release. Press NEXT and ▼ simultaneously for 5 seconds and release. If the screen in Step 2CS does not appear, the lock on the valve is activated. To unlock, press ▼, NEXT, ▲ and REGEN in sequence, then press NEXT and ▼ simultaneously for 5 seconds and release. Press NEXT and ▼ simultaneously for 5 seconds and release.

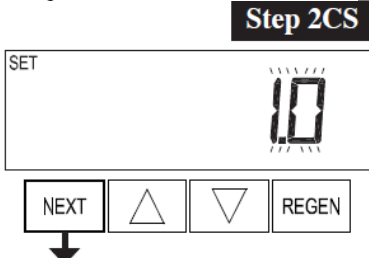

Step 2CS

Step 2CS – Use ▲ or ▼ to select 1.0 for 1” valve.
 Note: - Do not select 1.0t for simplex Filters.

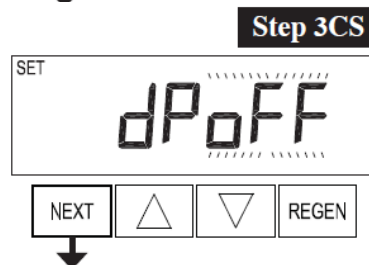

Step 3CS

Step 3CS – Select “dP OFF” the use of an outside signal to initiate a regeneration. Select oFF - feature not used. Other options are described below.

Press NEXT to go to Step 4CS. Press REGEN to return to previous step.

Step 4CS

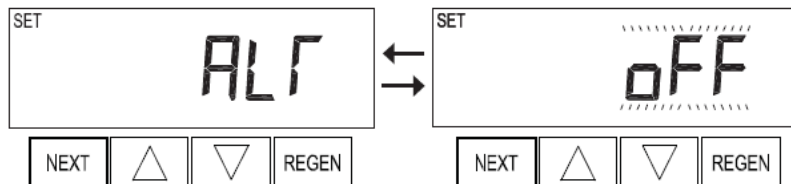

Step 4CS – Select “OFF” when none of features are used using ▲ or ▼ buttons. Press NEXT to exit Configuration Settings. Press REGEN to return to previous step.

EXIT TO DISPLAY SCREENS

2.6) Installer Display Settings

Step 1I



Step 1I - To enter Installer Display press NEXT and ▲ simultaneously for about 5 seconds and release.

Step 2I



Step 2I – Day Override: Set the number of days between regenerations. Press NEXT to go to step 3I. Press REGEN to return to previous step.

Step 3I



Step 3I – Next Regeneration Time (hour): Set the hour of day for regeneration using ▲ or ▼. The default time is 2:00. Press NEXT to go to step 4I. Press REGEN to return to previous step.

Step 4I

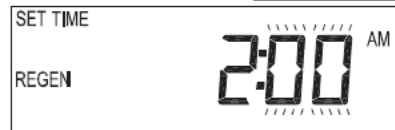

Step 4I – Next Regeneration Time (minutes): Set the minutes of day for regeneration using ▲ or ▼. This display will not be shown if “on 0” is selected in Set Regeneration Time Option in OEM Filter System Setup or OEM Filter System Setup. Press NEXT to exit Installer Display Settings. Press REGEN to return to previous step.

Exit Installer Display Settings

2.7) OEM Filter System Setup

Step 1F

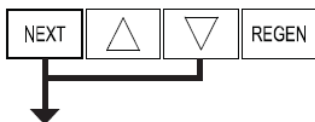

Step 1F: - Press NEXT and ▼ simultaneously for 5 seconds and release.

Step 2F



Step 2F: - Choose "FILTERING BACKWASH" using ▲ or ▼. Press NEXT to go to Step 3F. Press REGEN to exit OEM Filter System Setup.

Step 3F



Step 3F: - Select 10-minute time for the first/backwash cycle using ▲ or ▼. Press NEXT to go to Step 4F. Press REGEN to return to previous step.

Step 4F

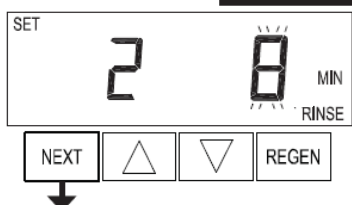

Step 4F: - Select 8-minute time for second/fast rinse cycle using ▲ or ▼. Press NEXT to go to step 5F.

Step 5F



Step 5F: - Set the volume regeneration trigger "off" using ▲ or ▼ to adjust the number of gallons as per specifications of filter model.

Step 6F

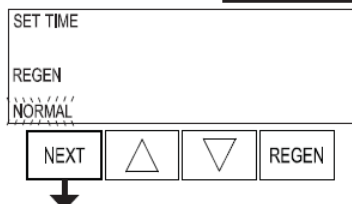

Step 6F: - Set "NORMAL" regeneration time so that the regeneration will always occur at preset time.

Step 7F

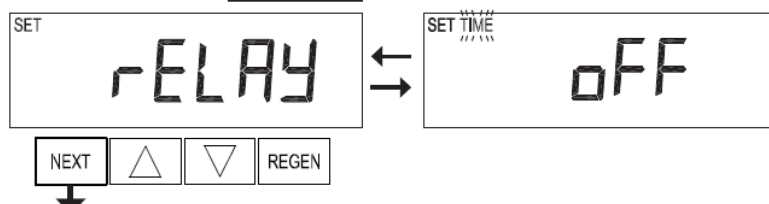

Step 7F: - Set relay operation "off" using ▲ or ▼ buttons so that relay should never energize.

Press next to go to step 7F. Press REGEN to return to previous step.

Exit OEM Filter System Setup

2.1) Diagnostics

Step 1D

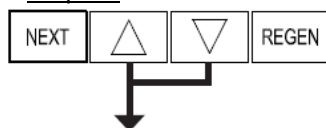

Step 1D: - Press ▲ and ▼ simultaneously for 5 seconds and release. If screen in Step 2D does not appear the lock on the valve is activated. To unlock press ▼, NEXT, ▲, REGEN in sequence, then press ▲ and ▼ simultaneously for 5 seconds and release.

Step 2D

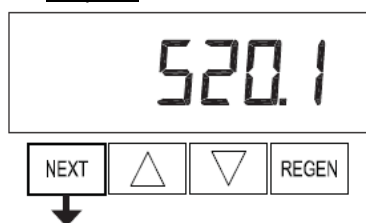

Step 2D: - Software version. Press NEXT to go to step 3D. Press REGEN to exit Diagnostics.

Step 3D

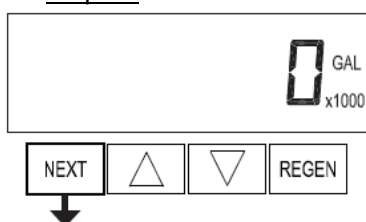

Step 3D: - This display shows the total gallons of volume filtered since startup. This display will be equal to zero if water meter is not installed. Press NEXT button to go to step 4D. Press REGEN to return to previous step.

Step 4D

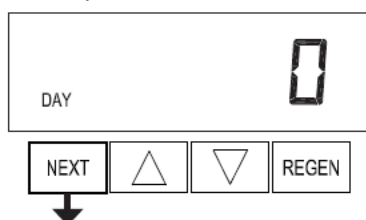

Step 4D: - This display shows the total days since start-up. Press the NEXT button to go to step 5D. Press REGEN to return to previous step.

Step 5D

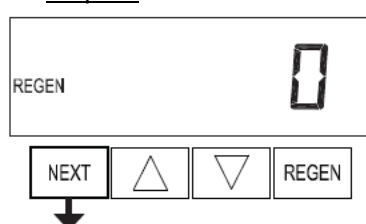

Step 5D: - This display shows the total number of regenerations that have occurred since startup. Press the NEXT button to go to Step 6D. Press REGEN to return to previous step.

Step 6D

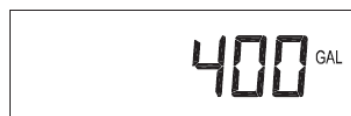
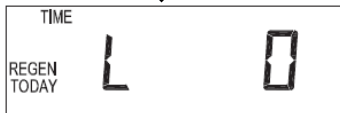

Step 6D: - This display shows a history of the last 10 errors generated by the control during operation. Press ▲ or ▼ to view each recorded error.

Step 7D**Step 8D****Step 9D****Step 10D****Step 11D**

Step 7D: - This display shows the days since the last regeneration occurred. Press NEXT to go to Step 8D. Press REGEN to return to previous step.

Step 8D: - This display shows the volume of water that has been filtered since the last regeneration. This display will equal zero when a water meter is not installed. Press NEXT to go to step 9D. Press REGEN to return to previous step.

Step 9D: - This display shows day 0 (for today) and flashes the volume of water filtered today. Pressing ▲ will show day 1 (which would be yesterday) and flashes the volume of water filtered on that day. Continue to press ▲ to show the maximum volume of water filtered for the last 63 days. If a regeneration occurred on the day, the word "REGEN" will also be displayed. This display will show dashes if a water meter is not installed. Press NEXT at any time to go to Step 10D. Press REGEN to return to previous step.

Step 10D: - MAV Drive History in the direction of retracted piston rod position. Up to a four-digit number will appear after the "L" which stands for latest and "A" which stands for average. Drive time is measured in 1/100 of a second. Press NEXT at any time to go to Step 11D. Press REGEN to return to previous step.

Step 11D: - MAV Drive History in the direction of extended piston rod position. Up to a four-digit number will appear after the "L" which stands for latest and "A" which stands for average. Press and hold ▲ and ▼ for 3 seconds while in Step 13D to reset the MAV drive history in both the extended and retracted piston rod position. Press NEXT at any time exit Diagnostics. Press REGEN to return to previous step.

2.2) Programming Summary

2.2.1) Configuration settings

Press NEXT and ▼ simultaneously for 5 seconds and repeat this step again.

Step #	Value	Description
2CS	1.0	Valve Size
3CS	dp oFF	No regeneration trigger
4CS	oFF	No MAV Installed

2.2.2) OEM Filter System Setup

Press NEXT and ▼ simultaneously for 5 seconds.

Step #	Value	Description
2F	Filtering Backwash	Regeneration method
3F	10	Backwash time in minutes
4F	8	Rinse time in minutes
5F	oFF	Regeneration trigger by volume
6F	oFF	Relay energized during error state

2.2.3) Installer Display Settings

Press NEXT and ▲ simultaneously for 5 Seconds.

Step #	Value	Description
2I	1	1 day between regenerations
3I	Low Demand Hour	Scheduled regeneration hour
4I	Low Demand minutes of hour	Scheduled regeneration minutes

3) CONTROL VALVE

3.1) Valve Specifications

WS1EE

**WATER
SPECIALIST
CONTROL
VALVE**



shown with optional bypass

Certified to NSF/ANSI 44, 61 and 372.

- Solid state microprocessor with easy access front panel settings
- Service flow rate of 27 gpm, backwash 27 gpm
- Front panel display for time of day, days until next regeneration, volume remaining, current flow rate and total volume used (Totalizer)
- Four methods to initiate regeneration; meter immediate, meter delayed, time clock delayed or pressure differential
- Optional double backwash feature offers optimum regeneration, cleaning ability and efficiency
- Fully adjustable cycle times with 6-cycle control delivers controlled backwash, downflow brining/slow rinse, second backwash, fast rinse, refill and downflow service
- Coin Cell Lithium battery back-up with a 8 hour carry over
- Backwash and brining ability to 21" diameter tanks
- Downflow or upflow brining regeneration
- 12-volt output AC Adapter provides safe and easy installation
- Control valve design provides optimum service and backwash rates
- Post treated water regenerant refill
- Patented one piece expanding seal spacer stack assembly U.S. Patent 6,402,944
- Patented linearly reciprocating piston operation U.S. Patent 6,444,127
- Reliable and proven DC drive

Minimum/Maximum Operating Pressures	20 psi (138 kPa or 1.4 bar) -125 psi (862 kPa or 8.6 bar)
Minimum/Maximum Operating Temperatures	40°F (4°C) - 110°F (43°C)
Power Adapter:	
Supply Voltage	110VAC
Supply Frequency	60Hz
Output Voltage	12VAC
Output Current	500mA
No user serviceable parts are on the PC board, the motor, or the power adapter. The means of disconnection from the main power supply is by unplugging the power adapter from the wall.	

Service flow rate 1" (includes bypass and meter)	27 gpm (102.2 lpm, 6.1 m3/h) @15 psig (103 kPa) drop
Backwash flow rate 1" (includes bypass)	27 gpm (102.2 lpm, 6.1 m3/h) @25 psig (172 kPa) drop
Minimum/Maximum Operating Pressures	20 psi (138 kPa) -125 psi (862 kPa)
Minimum/Maximum Operating Temperatures	40°F (4°C) - 110°F (43°C)
Drain Line Flow Controls	1" DLFC (V3190-XX)
Inlet / Outlet Fitting Options	See Drawings and Part Numbers
Distributor Tube Opening WS1 Valve	1.05" outside diameter (¾" NPS)
Tank Thread	2½" - 8 NPSM
Control Valve Weight	4.5 lbs. 2.0 kg
PC Board Memory	Nonvolatile EEPROM (electrically erasable programmable read only memory)
Compatible with regenerants/chemicals	Sodium chloride, potassium chloride, potassium permanganate, sodium bisulfite, chlorine and chloramines

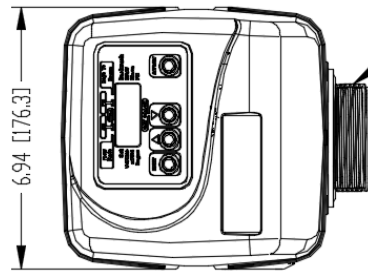
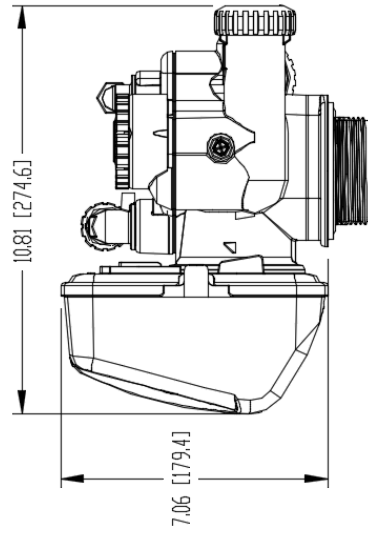
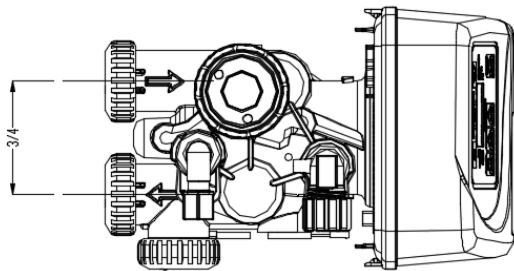

2 1/2 - 8 NPSM

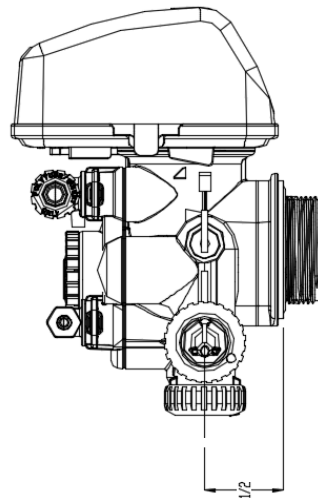

3.2) Control Valve Functions and Cycles

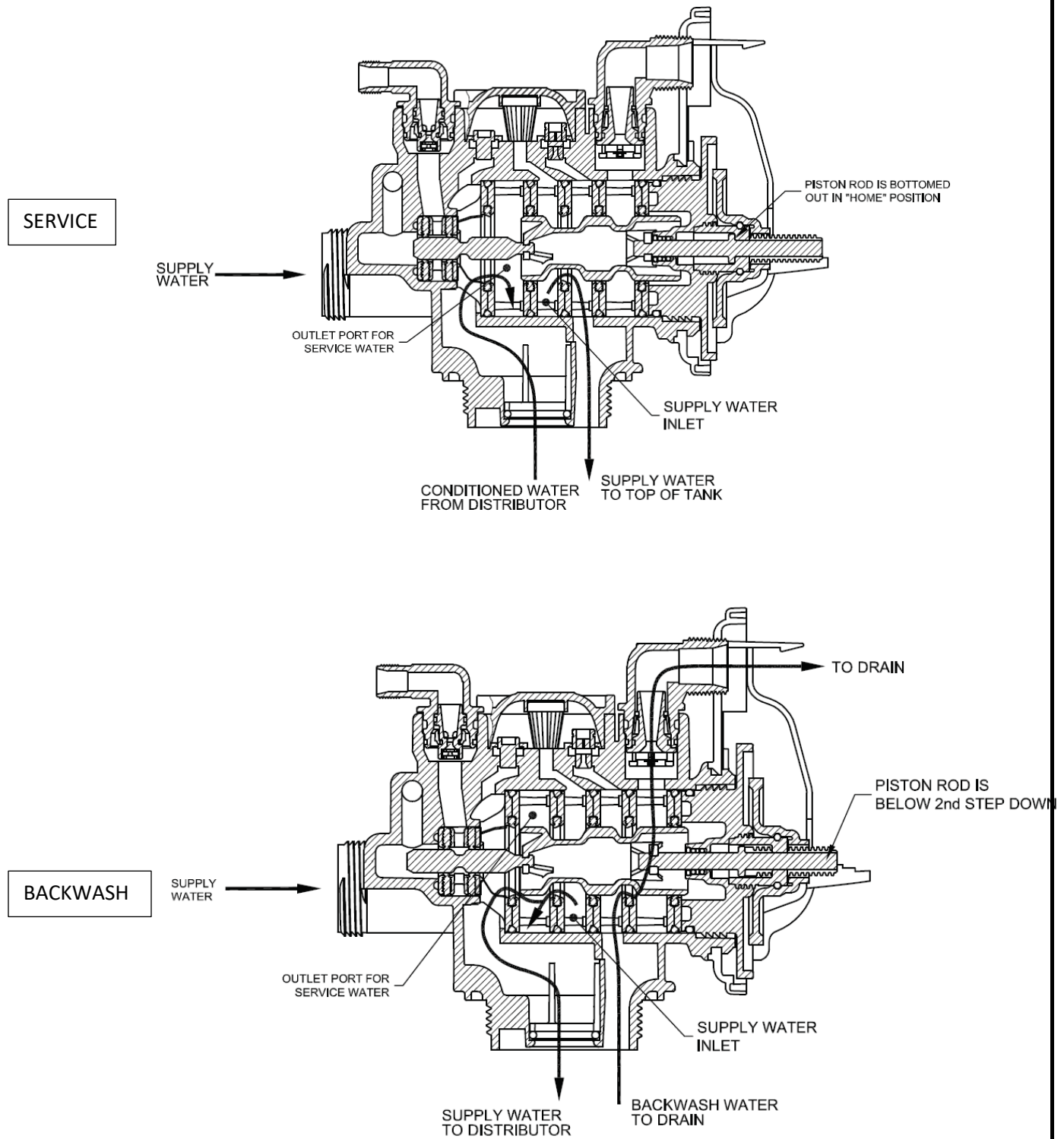

RINSE

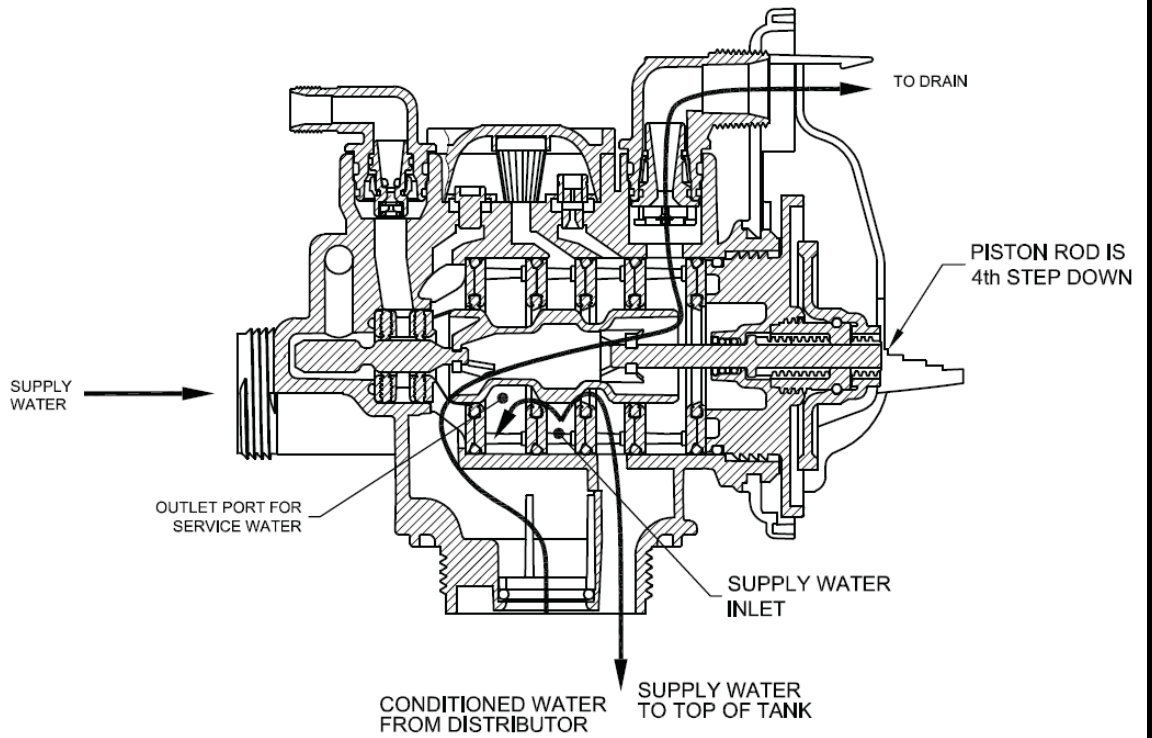

SERVICE

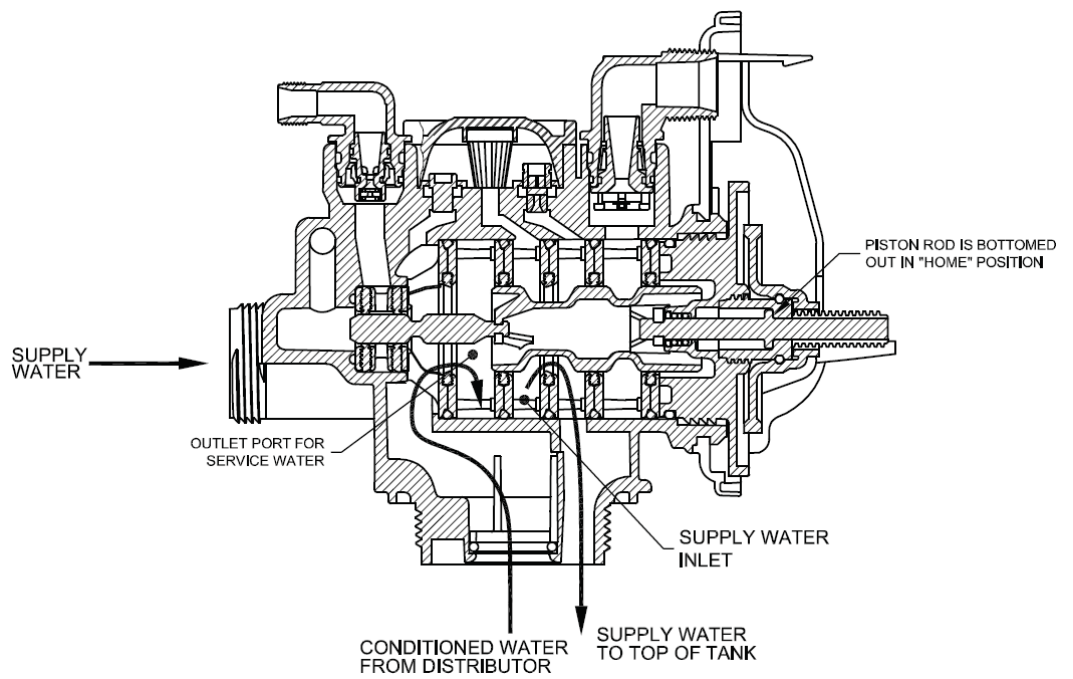

3.3) Components of Control Valve

3.3.1) Front Cover and PC Board

Drawing No.	Order No.	Description	Quantity
1	V3175EE-01	WS1EE FRONT COVER ASSEMBLY	1
2	V3107-01	WS1 MOTOR	1
3	V3106-01	WS1 DRIVE BRACKET & SPRING CLIP	1
4	V3408EE-04BOARD	WS1THRU/2 EE PCB 5 DIGIT REPL	1
5	V3110	WS1 DRIVE GEAR 12X36	3
6	V3109	WS1 DRIVE GEAR COVER	1
Not Shown	V3186	WS1 AC ADAPTER 120V-12V	1
	V3186-01	WS1 AC ADAPTER CORD ONLY	
Not Shown	V3178	WS1 Drive Back Plate	1

AC Adapter	U.S.	International
Supply Voltage	120 VAC	230V AC
Supply Frequency	60 Hz	50 Hz
Output Voltage	12 VAC	12 VAC
Output Current	500 mA	500 mA

Wiring for Correct On/Off Operation	
PC Board Relay Terminal Block	Relay
RLY 1	Coil -
+ COM	Coil +

Refer to Control Valve Service Manual for other drawings and part numbers.

Relay Specifications: 12V DC Relay with a coil resistance not less than 80 ohms. If mounting relay under the cover check for proper mounting dimensions on the backplate.

When replacing the battery, align positives and push down to fully seat.

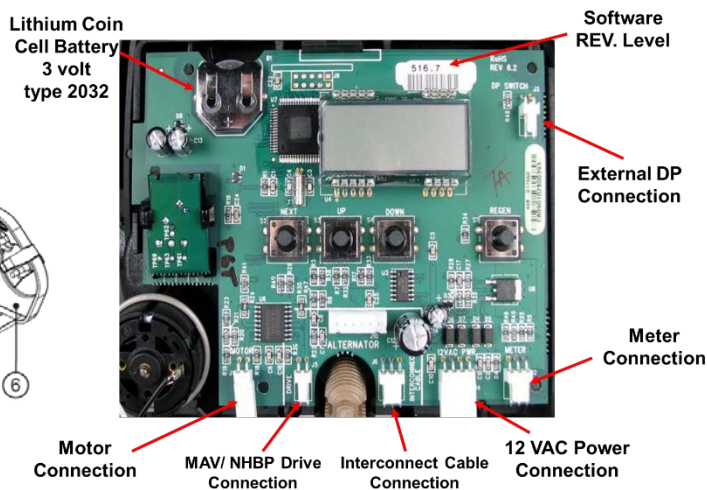
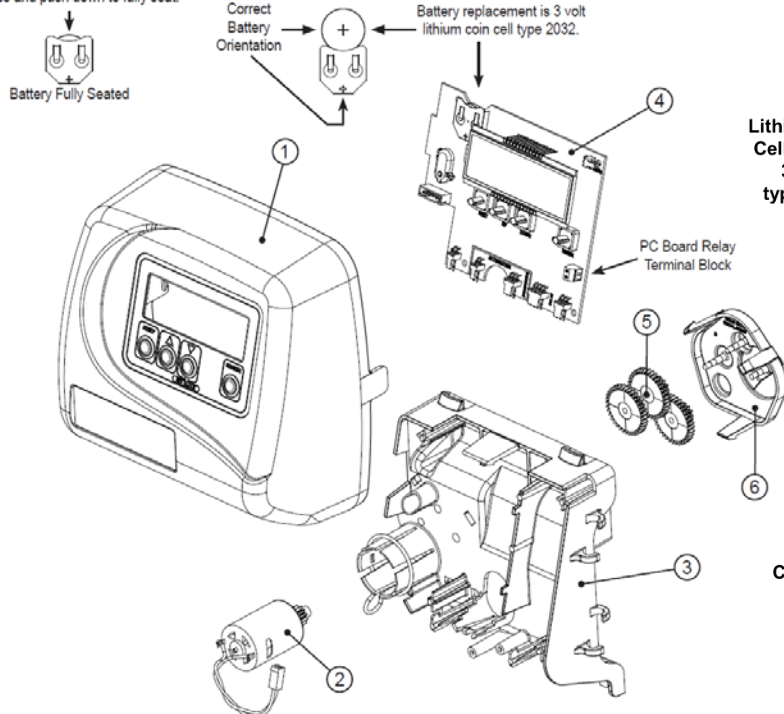

3.3.2) Drive Cap Assembly, Spacer Stack Assembly and Main body

Drawing No.	Order No.	Description	Quantity
1	V3005-02	WS1 Spacer Stack Assembly	1
2	V3004	Drive Cap ASY	1
3	Back Plate	Refer to Programming and Cover Drawing Manual	1
4	V3011	WS1 Piston Downflow ASY	1
5	V3135	O-ring 228	1
6	V3180	O-ring 337	1
7	V3105	O-ring 215 (Distributor Tube)	1
Not Shown	V3001	WS1 Body ASY Downflow	1

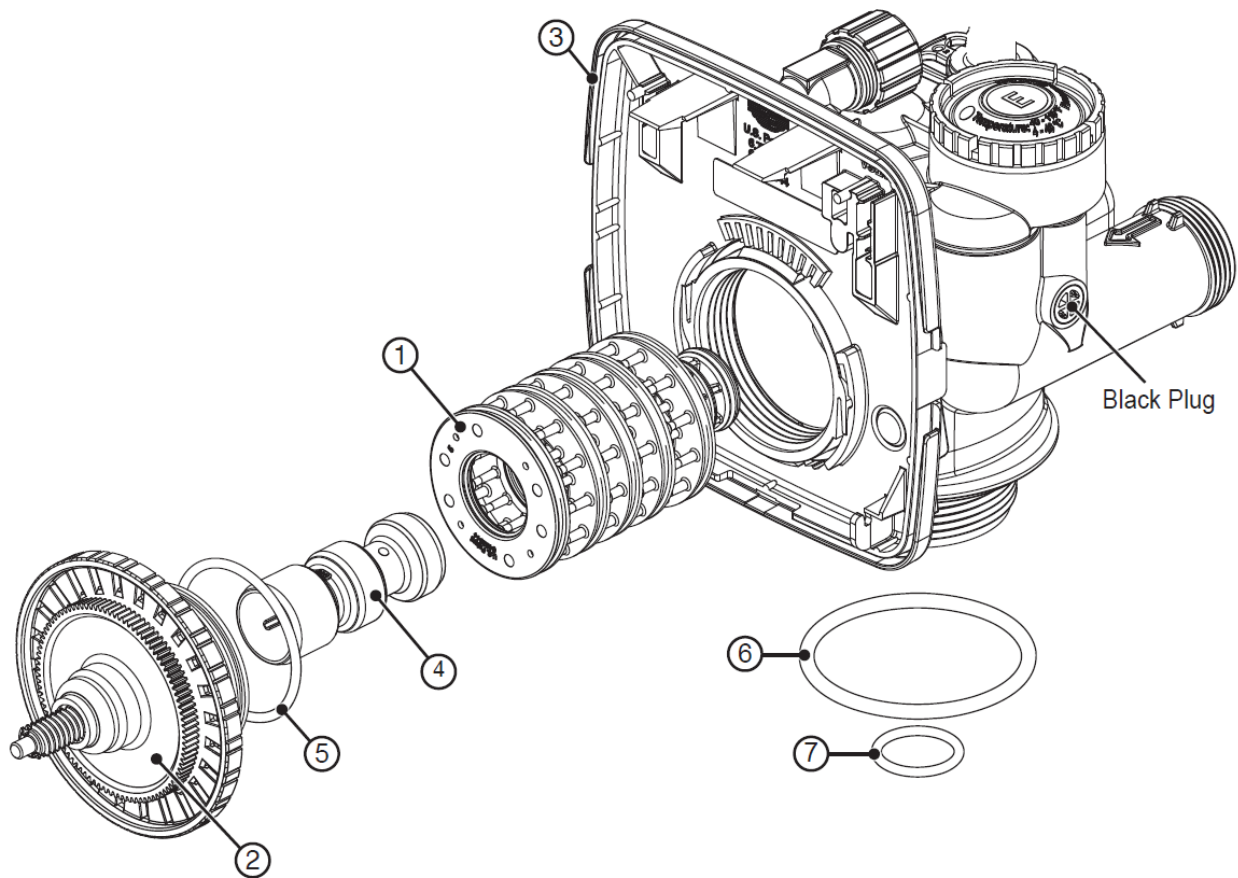

3.3.3) Drain Line Flow Control

Drain Line 3/4"			
Drawing No.	Order No.	Description	Quantity
1	H4615	Elbow Locking Clip	1
2	PKP10TS8-BULK	Polytube insert 5/8	Option
3	V3192	WS1 Nut 3/4 Drain Elbow	Option
4*	V3158-01	WS1 Drain Elbow 3/4 Male	1
	V3158-02	WS1 Drain Elbow 3/4 Male No Silencer	
5	V3163	O-ring 019	1
6*	V3159-01	WS1 DLFC Retainer ASY	1
7	V3162-007	WS1 DLFC 0.7 gpm for 3/4	One DLFC must be used if 3/4 fitting is used
	V3162-010	WS1 DLFC 1.0 gpm for 3/4	
	V3162-013	WS1 DLFC 1.3 gpm for 3/4	
	V3162-017	WS1 DLFC 1.7 gpm for 3/4	
	V3162-022	WS1 DLFC 2.2 gpm for 3/4	
	V3162-027	WS1 DLFC 2.7 gpm for 3/4	
	V3162-032	WS1 DLFC 3.2 gpm for 3/4	
	V3162-042	WS1 DLFC 4.2 gpm for 3/4	
	V3162-053	WS1 DLFC 5.3 gpm for 3/4	
	V3162-065	WS1 DLFC 6.5 gpm for 3/4	
	V3162-075	WS1 DLFC 7.5 gpm for 3/4	
	V3162-090	WS1 DLFC 9.0 gpm for 3/4	
V3162-100	WS1 DLFC 10.0 gpm for 3/4		

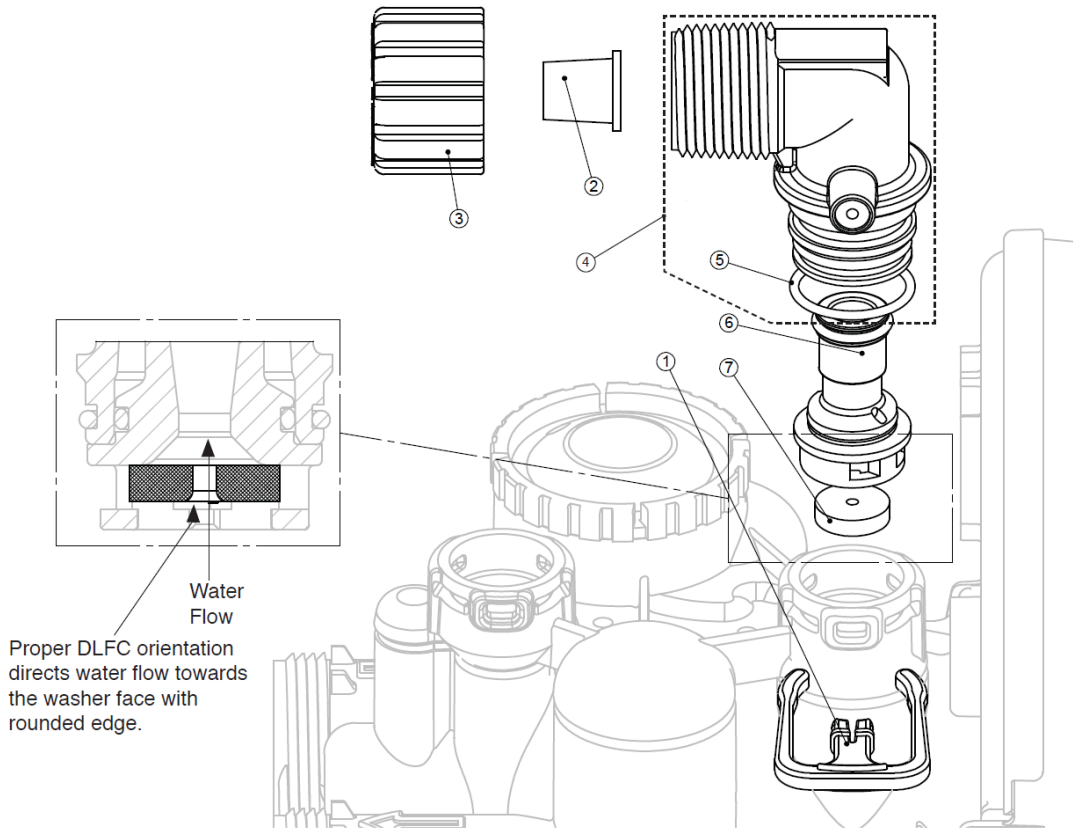

Drain Line 1"			
Drawing No.	Order No.	Description	Quantity
1	H4615	Elbow Locking Clip	1
2*	V3166	WS1 Drain FTG Body 1	1
	V3166-01	FTG Flow Control Body Female 1	
3*	V3167	WS1 Drain FTG Adapter 1	1
4*	V3163	O-ring 019	1
5*	V3150	WS1 Split Ring	1
6*	V3151	WS1 Nut 1" QC	1
7*	V3105	O-ring 215	1
8	V3190-090	WS1 DLFC 9.0 gpm for 1	One DLFC must be used if 1" fitting is used
	V3190-100	WS1 DLFC 10.0 gpm for 1	
	V3190-110	WS1 DLFC 11.0 gpm for 1	
	V3190-130	WS1 DLFC 13.0 gpm for 1	
	V3190-150	WS1 DLFC 15.0 gpm for 1	
	V3190-170	WS1 DLFC 17.0 gpm for 1	
	V3190-200	WS1 DLFC 20.0 gpm for 1	
	V3190-250	WS1 DLFC 25.0 gpm for 1	

* Can be ordered as a set. Order number V3008-02, description: WS1 Drain FTG 1 Straight.

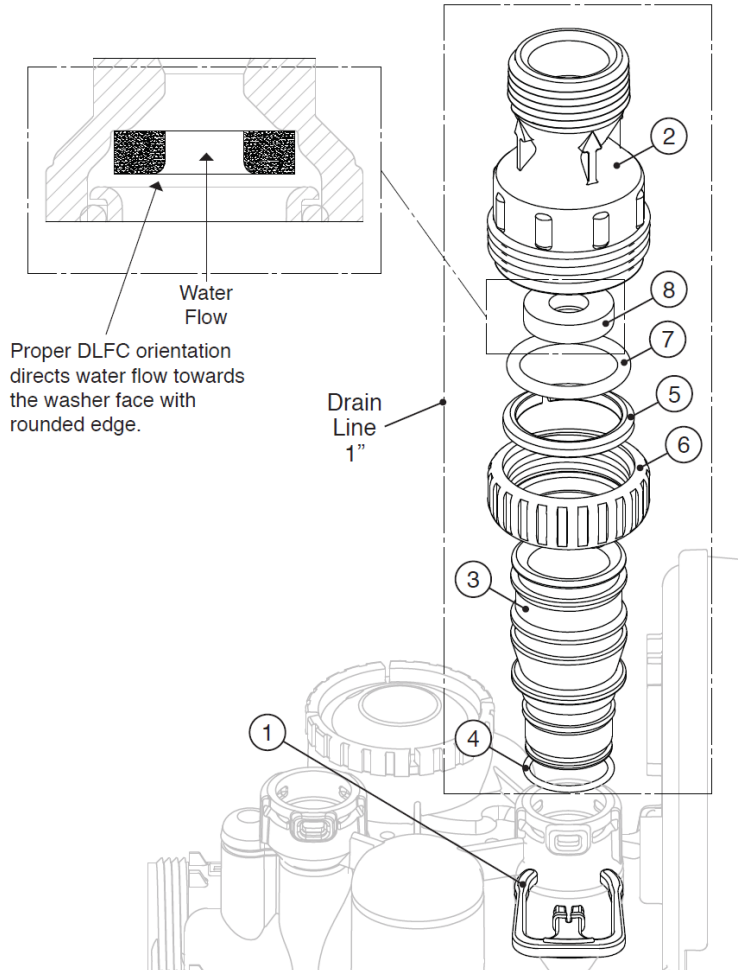

3.3.4) Outlet Meter Assembly

Drawing No.	Order No.	Description	Quantity
1	V3151	WS1 Nut 1" QC	1
2	V3003*	WS1 Meter ASY	1
3	V3118-01	WS1 Turbine ASY	1
4	V3105	O-ring 215	1

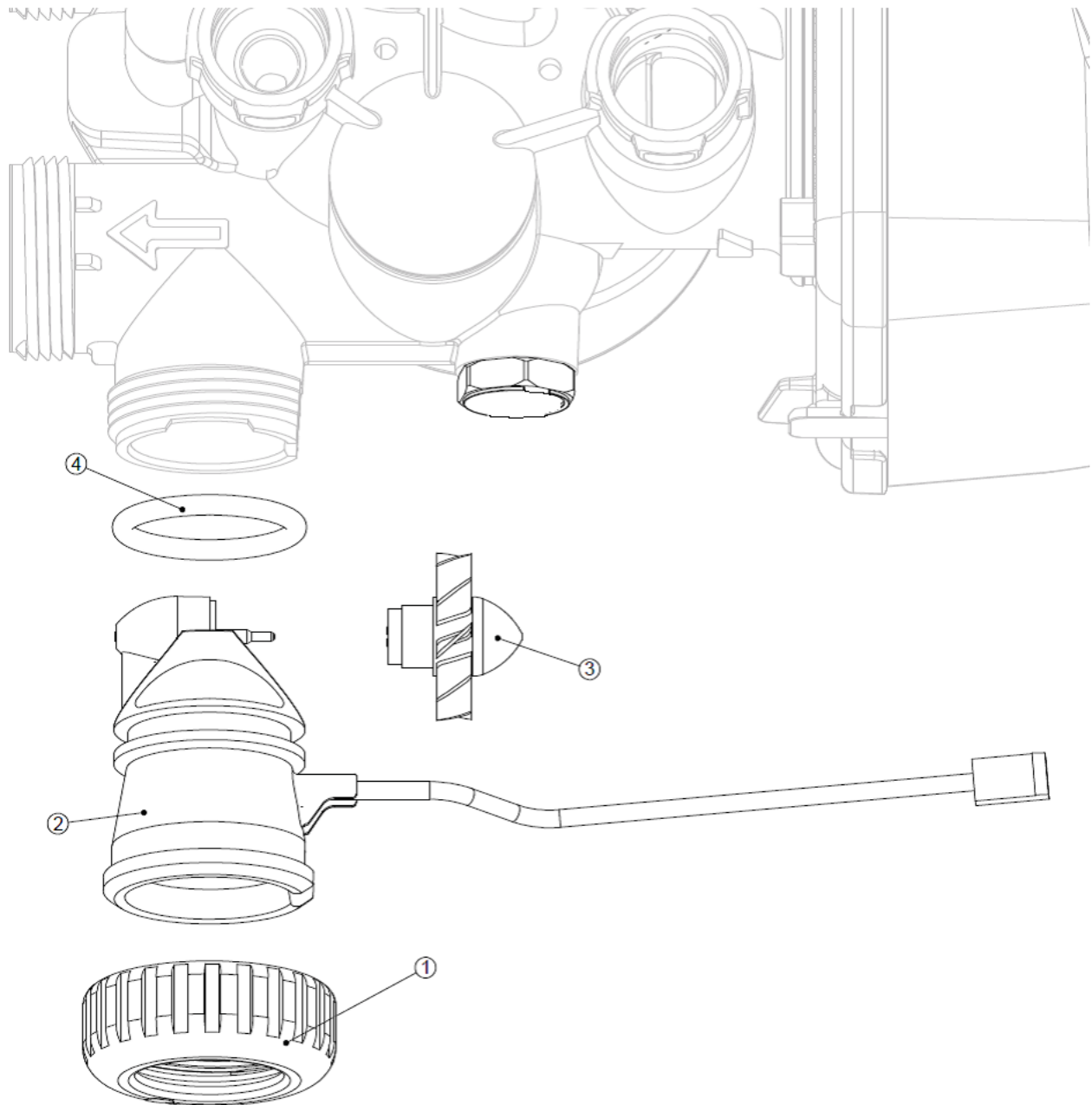

THIS WATER METER SHOULD NOT BE USED AS THE PRIMARY MONITORING DEVICE FOR CRITICAL OR HEALTH EFFECT APPLICATIONS.

3.3.5) Bypass Valve Components

Drawing No.	Order No.	Description	Quantity
1	V3151	WS1 Nut 1" Quick Connect	2
2	V3150	WS1 Split Ring	2
3	V3105	O-Ring 215	2
4	V3145	WS1 Bypass 1" Rotor	2
5	V3146	WS1 Bypass Cap	2
6	V3147	WS1 Bypass Handle	2
7	V3148	WS1 Bypass Rotor Seal Retainer	2
8	V3152	O-ring 135	2
9	V3155	O-ring 112	2
10	V3156	O-ring 214	2

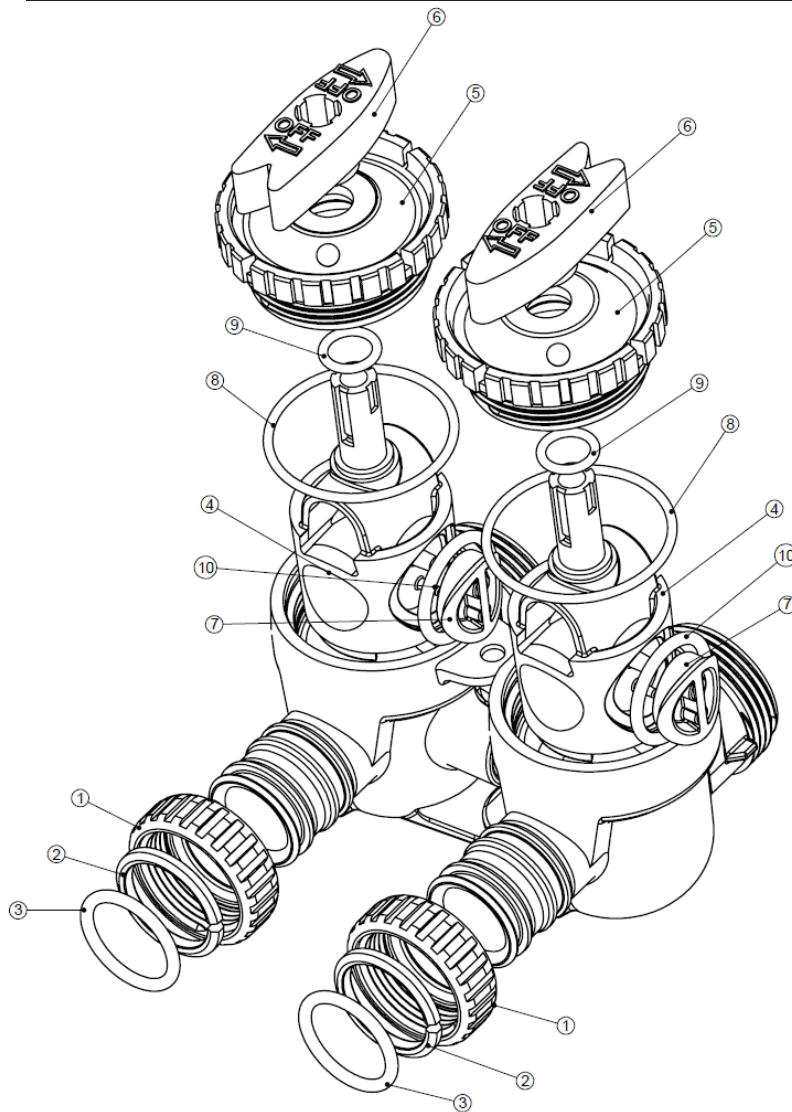

3.3.6) Installation Fitting Assemblies

V3007 WS1 Fitting 1" PVC Male NPT Elbow Assembly			
Drawing No.	Order No.	Description	Quantity
1	V3151	WS1 NUT 1" QUICK CONNECT	2
2	V3150	WS1 SPLIT RING	2
3	V3105	O-RING 215	2
4	V3149	WS1 FITTING 1 PVC MALE NPT ELBOW	2

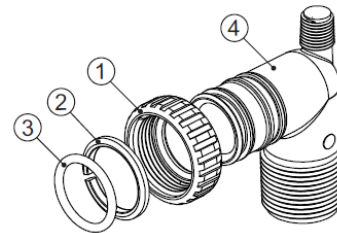

V3007-01 WS1 Fitting 3/4" & 1" PVC Solvent 90° Assembly			
Drawing No.	Order No.	Description	Quantity
1	V3151	WS1 NUT 1" QUICK CONNECT	2
2	V3150	WS1 SPLIT RING	2
3	V3105	O-RING 215	2
4	V3189	WS1 FITTING 3/4&1 PVC SOLVENT 90	2

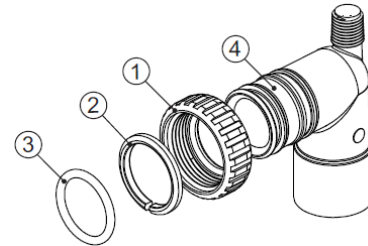

V3007-02LF WS1 Fitting 1" Brass Sweat Assembly LF			
Drawing No.	Order No.	Description	Quantity
1	V3151	WS1 NUT 1" QUICK CONNECT	2
2	V3150	WS1 SPLIT RING	2
3	V3105	O-RING 215	2
4	V3188-LF	WS1 FITTING 1 BRASS SWEAT ASSEMBLY LF	2

Do not install in California.

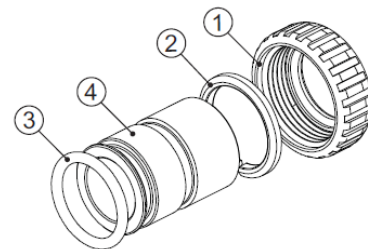

V3007-03LF WS1 Fitting 3/4" Brass Sweat Assembly LF			
Drawing No.	Order No.	Description	Quantity
1	V3151	WS1 NUT 1" QUICK CONNECT	2
2	V3150	WS1 SPLIT RING	2
3	V3105	O-RING 215	2
4	V3188-01LF	WS1 FITTING 3/4 BRASS SWEAT LF	2

Do not install in California.

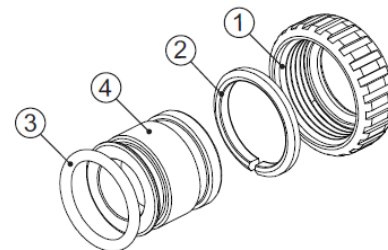

V3007-04 WS1 Fitting 1" Plastic Male NPT Assembly			
Drawing No.	Order No.	Description	Quantity
1	V3151	WS1 NUT 1" QUICK CONNECT	2
2	V3150	WS1 SPLIT RING	2
3	V3105	O-RING 215	2
4	V3164	WS1 FITTING 1" PLASTIC MALE NPT	2

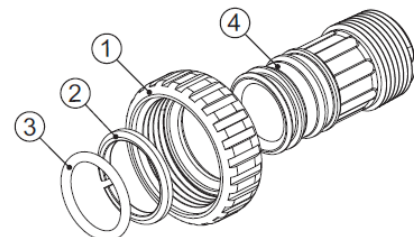

FILTER INSTALLATION AND USER GUIDE

V3007-05 WS1 Fitting 1-1/4" Plastic Male NPT Assembly			
Drawing No.	Order No.	Description	Quantity
1	V3151	WS1 NUT 1" QUICK CONNECT	2
2	V3150	WS1 SPLIT RING	2
3	V3105	O-RING 215	2
4	V3317	WS1 FITTING 1-1/4" PLASTIC MALE NPT	2

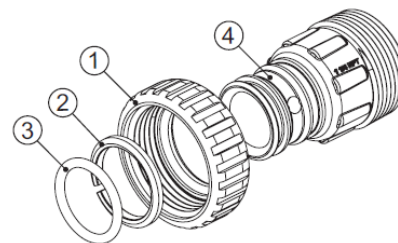

V3007-09LF WS1 Fitting 1-1/4" & 1-1/2" Brass Sweat Assembly LF			
Drawing No.	Order No.	Description	Quantity
1	V3151	WS1 NUT 1" QUICK CONNECT	2
2	V3150	WS1 SPLIT RING	2
3	V3105	O-RING 215	2
4	V3375-LF	WS1 FITTING 1-1/4" & 1-1/2" BRASS SWEAT LF	2

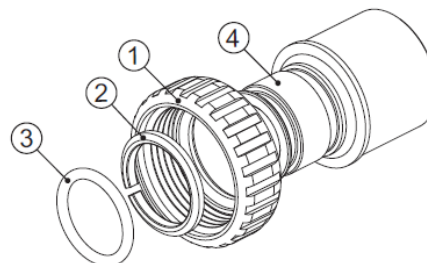

V3007-12LF WS1 Fitting 3/4" Brass SharkBite Assembly LF			
Drawing No.	Order No.	Description	Quantity
1	V3151	WS1 NUT 1" QUICK CONNECT	2
2	V3150	WS1 SPLIT RING	2
3	V3105	O-RING 215	2
4	V3628-LF	WS1 FTG 3/4 BRASS SHARKBITE LF	2

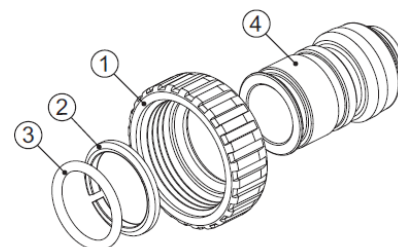

V3007-13LF WS1 Fitting 1" Brass SharkBite Assembly LF			
Drawing No.	Order No.	Description	Quantity
1	V3151	WS1 NUT 1" QUICK CONNECT	2
2	V3150	WS1 SPLIT RING	2
3	V3105	O-RING 215	2
4	V3629-LF	WS1 FTG 1" BRASS SHARKBITE LF	2

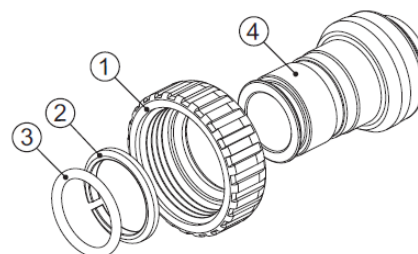

V3007-15 WS1 FTG 3/4 JG QC 90 Assembly			
Drawing No.	Order No.	Description	Quantity
1	V3151	WS1 NUT 1 QC	2
2	V3150	WS1 SPLIT RING	2
3	V3105	O-RING 215	2
4	V3790	WS1 ELBOW 3/4 QC W/STEM	2

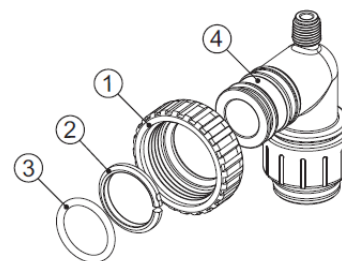

V3007-17 WS1 FTG 1" JG QC Assembly			
Drawing No.	Order No.	Description	Quantity
1	V3105	O-RING 215	2
2	V3150	WS1 SPLIT RING	2
3	V3151	WS1 NUT 1 QC	2
4	V4045	WS1 FTG 1 INCH QC	2

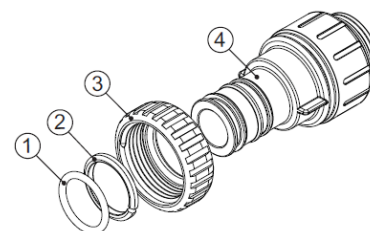

3.3.7) Service Spanner Wrench

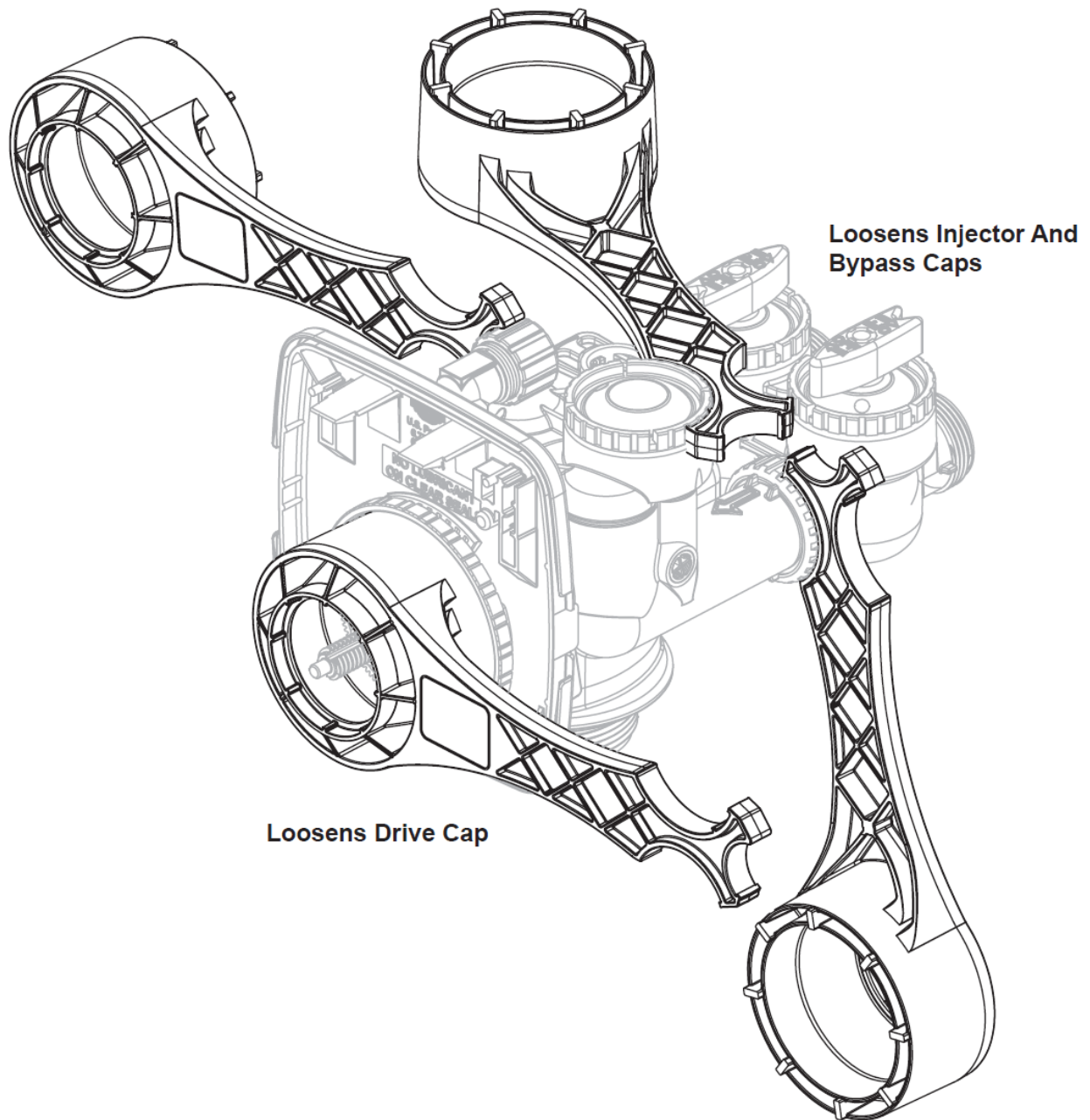

4) QUICK REFERENCE GUIDE

Immediate Regeneration: - Press and hold “REGEN” button for more than 3 seconds. Press “REGEN” button to advance the unit to next cycle in regeneration.

Delayed Regeneration: - Press and release “REGEN” button once the “REGEN TODAY” will be flashing on screen. Now the regeneration will occur tonight at preset time. The delayed regeneration can be cancelled by pressing “REGEN” button again.

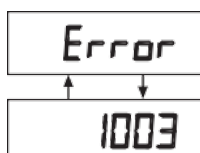

This error screen and error number will toggle. Contact Service Technician or OEM and report the error code.

NORMAL OPERATION

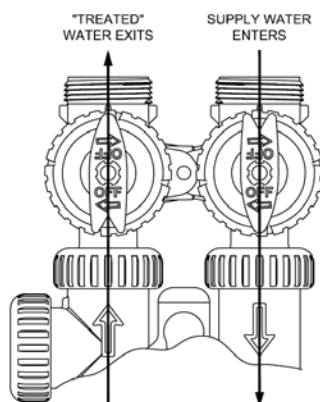

The inlet handle arrow must be in the direction of unit and outlet handle must direct away from the unit as given above.

BYPASS OPERATION

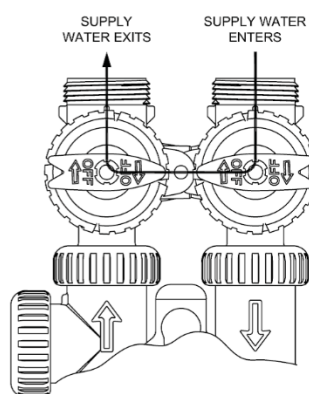

To shut off supply to the Unit the bypass valve handle must be in direction given above.

To Set Time of Day

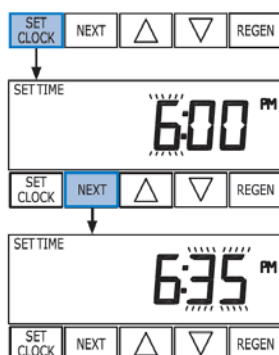

- Press “SET CLOCK” button.
- Hours will flash press up and down buttons to adjust hours to current hour of day. Then press “NEXT” button.
- By pressing up and down buttons adjust minutes. Then press “NEXT” button.
- The time is set and the valve display will return to normal display.

5) SERVICE INSTRUCTIONS

5.1) Front Cover Removal



Pull out on each side of the covers locking tabs

5.2) PC Board Removal

**Lift up on PC Board locking tab
Last to remove PC Board**

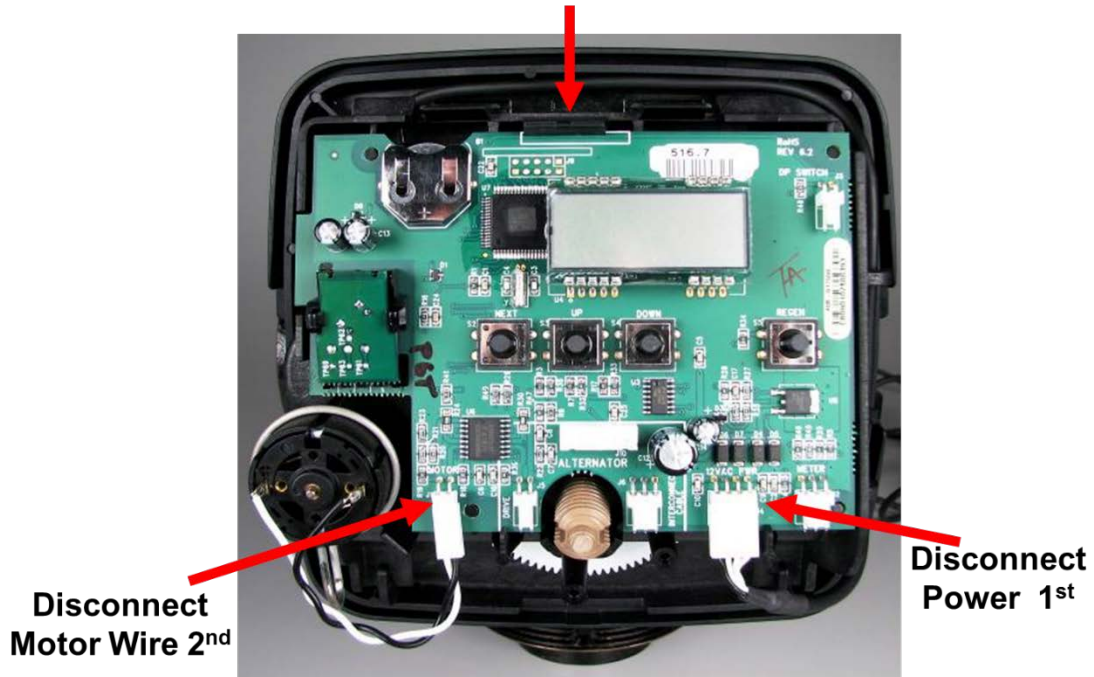

1. Lift up the locking tab and then pull out the PC board from top.
2. Disconnect the power cable first and then disconnect other cables.

**Lithium Coin Cell Battery
3 volt
type 2032**

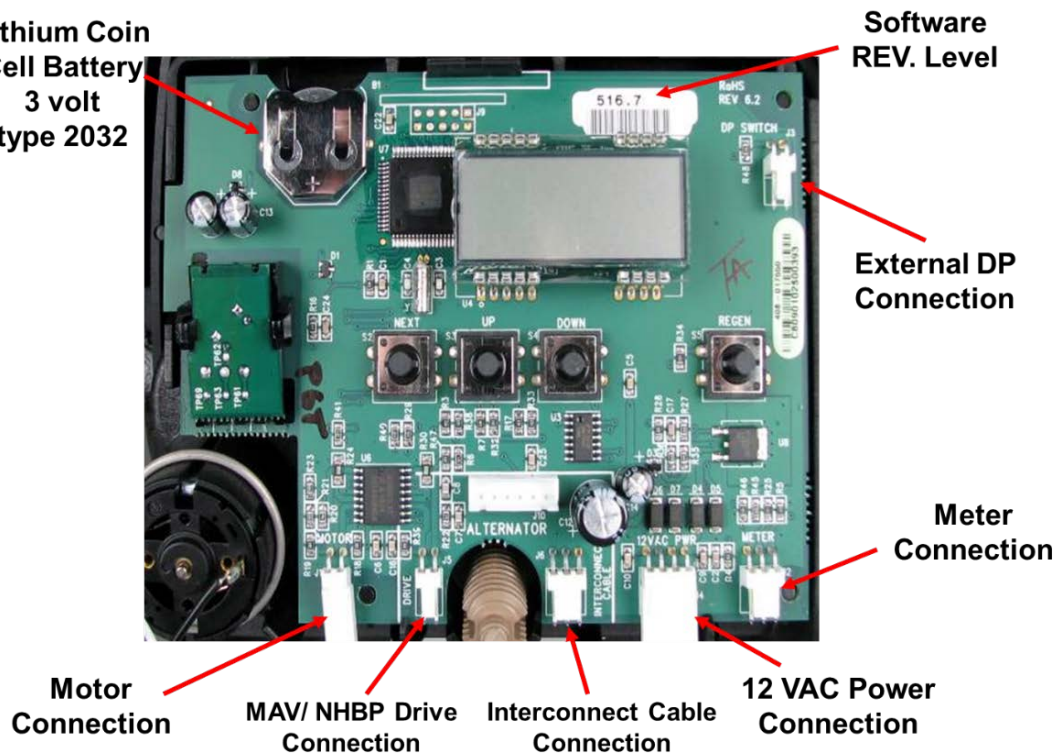

5.3) Drive Bracket Removal

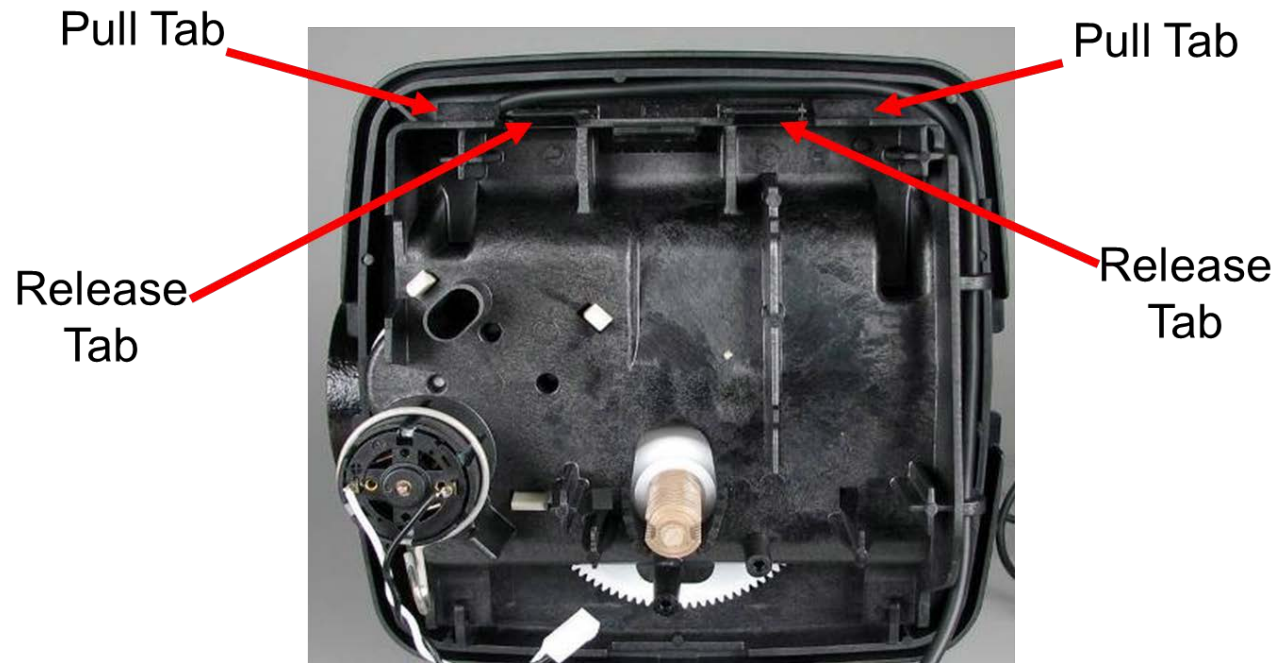

Lift up both release tabs with thumbs and use index fingers to pull out the pull tab.



Motor can be removed by pressing the locking spring to the right and then pull the motor out. Gearbox can be removed by pushing the beige colored locking tabs inwards.

5.4) Drive Cap Removal



Turn the drive cap counter clockwise with the closed end of service wrench.



Pull out the drive cap with main piston.

5.5) Piston Removal



Fully extend the piston by rotating white gear. Then put a side pressure in the direction of cavity to snap off the piston from rod.



The main piston is attached with snap off connection.

5.6) Stack Assembly Removal

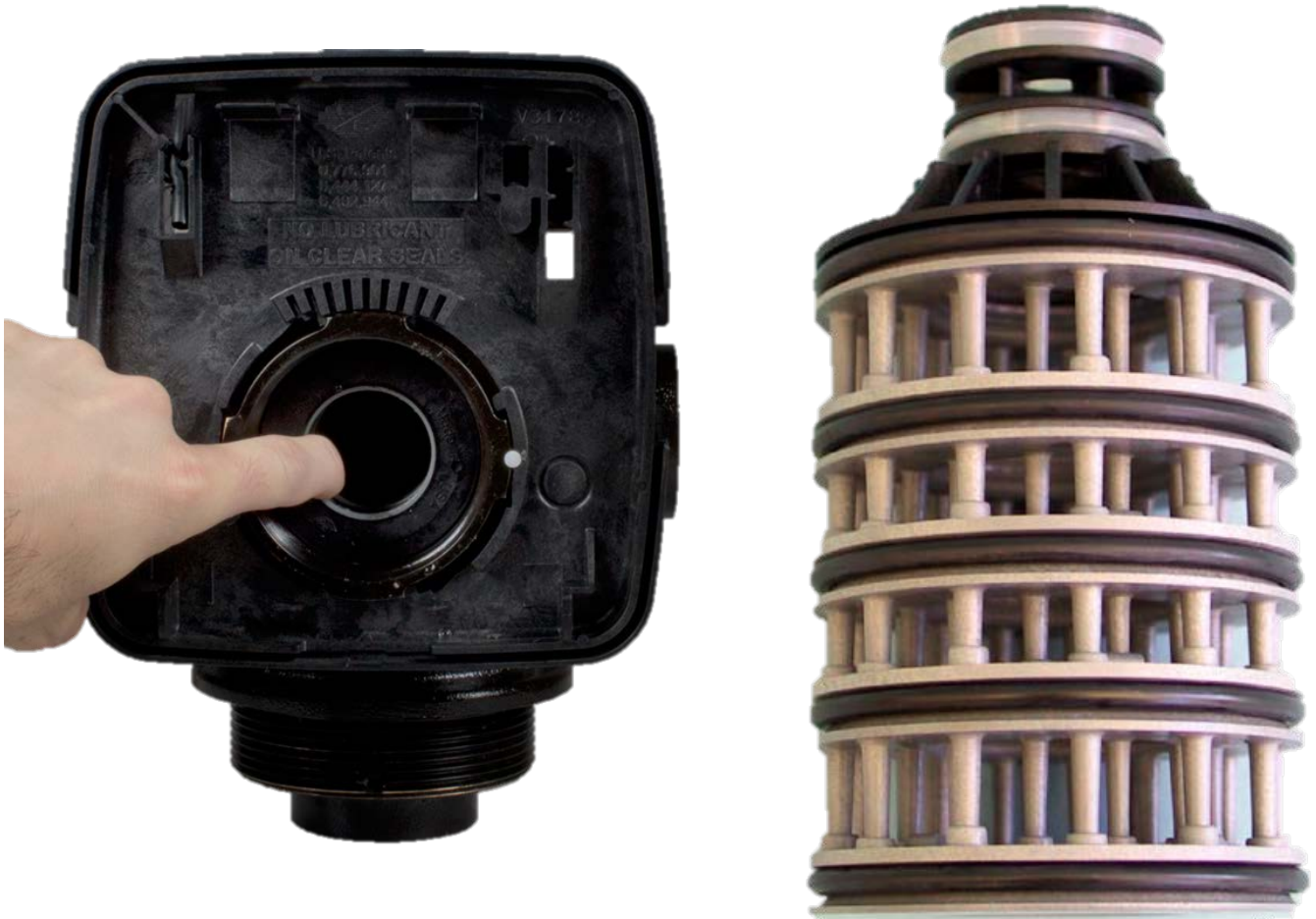

Stack assembly can be simply pulled out by hand from the control valve body.

6) TROUBLESHOOTING

6.1) Possible Error Codes

Possible Errors	
Code	Description
E1	Control unable to sense motor movement
Err-1001	
Err-101	
E2	Control Valve motor ran too short
Err-1002	
Err-102	
E3	Control Valve motor ran too long and unable to find next cycle
Err-1003	
Err-103	
Err-1004	Control Valve ran too long and timed out
Err-104	
Err-1006	MAV/NHWB motor ran too long
Err-106	
Err-1007	MAV/NHWB motor ran too short and stalled
Err-107	

6.2) Troubleshooting Procedures

Problem	Possible Cause	Solution
1. No Display on PC Board	a. No power at electric outlet	a. Repair outlet or use working outlet
	b. Control valve Power Adapter not plugged into outlet or power cord end not connected to PC board connection	b. Plug Power Adapter into outlet or connect power cord end to PC Board connection
	c. Improper power supply	c. Verify proper voltage is being delivered to PC Board
	d. Defective Power Adapter	d. Replace Power Adapter
	e. Defective PC Board	e. Replace PC Board
2. PC Board does not display correct time of day	a. Power Adapter plugged into electric outlet controlled by light	a. Use uninterrupted outlet
	b. Tripped breaker switch and/or	b. Reset breaker switch and/ or GFI switch
	c. Power outage	c. Reset time of day. If PC Board has battery back up present the battery may be depleted. See Front Cover and Drive Assembly drawing for instructions.
	d. Defective PC Board	d. Replace PC Board
3. Display does not indicate that water is flowing. Refer to user instructions for how the display indicates water is flowing	a. Bypass valve in bypass position	a. Turn bypass handles to place bypass in service position
	b. Meter is not connected to meter connection on PC Board	b. Connect meter to three pin connection labeled METER on PC Board
	c. Restricted/ stalled meter turbine	c. Remove meter and check for rotation or foreign material
	d. Meter wire not installed securely into three pin connector	d. Verify meter cable wires are installed securely into three pin connector labeled METER
	e. Defective meter	e. Replace meter
	f. Defective PC Board	f. Replace PC Board
4. Control valve regenerates at wrong time of day	a. Power outage	a. Reset time of day. If PC Board has battery back up present the battery may be depleted. See Front Cover and Drive Assembly drawing for instructions.
	b. Time of day not set correctly	b. Reset to correct time of day
	c. Time of regeneration set	c. Reset regeneration time
	d. Control valve set at "on 0" (immediate regeneration)	d. Check programming setting and reset to NORMAL (for a delayed regen time)
	e. Control valve set at "NORMAL + on 0" (delayed and/ or immediate)	e. Check programming setting and reset to NORMAL (for a delayed regen time)
5. Time of day flashes on and off	a. Power outage	a. Reset time of day. If PC Board has battery back up present the battery may be depleted. See Front Cover and Drive Assembly drawing for instructions.
6. Control valve does not regenerate when the REGEN button is depressed and held.	a. Broken drive gear or drive cap	a. Replace drive gear or drive cap assembly
	b. Broken Piston Rod	b. Replace piston rod
	c. Defective PC Board	c. Defective PC Board
7. Control valve does not regenerate automatically but does when the REGEN button is depressed and held	a. Bypass valve in bypass position	a. Turn bypass handles to place bypass in service position
	b. Meter is not connected to meter connection on PC Board	b. Connect meter to three pin connection labeled METER on PC Board
	c. Restricted/ stalled meter turbine	c. Remove meter and check for rotation or foreign material
	d. Incorrect programming	d. Check for programming error
	e. Meter wire not installed securely into three pin connector	e. Verify meter cable wires are installed securely into three pin connector labeled METER
	f. Defective meter	f. Replace meter
	g. Defective PC Board	g. Replace PC Board

Problem	Possible Cause	Solution
8. Hard or unfiltered water is being delivered	a. Bypass valve is open or faulty	a. Fully close bypass valve or replace
	b. Media is exhausted due to high water usage	b. Check program settings or diagnostics for abnormal water usage
	c. Meter not registering	c. Remove meter and check for rotation or foreign material
	d. Water quality fluctuation	d. Test water and adjust program values accordingly
	e. No regenerant or low level of regenerant in regenerant tank	e. Add proper regenerant to tank
	f. Control fails to draw in regenerant	f. Refer to Trouble Shooting Guide number 12
	g. Insufficient regenerant level in regenerant tank	g. Check refill setting in programming. Check refill flow control for restrictions or debris and clean or replace
	h. Damaged seal/stack assembly	h. Replace seal/stack assembly
	i. Control valve body type and piston type mix matched	i. Verify proper control valve body type and piston type match
	j. Fouled media bed	j. Replace media bed
9. Control valve uses too much regenerant	a. Improper refill setting	a. Check refill setting
	b. Improper program settings	b. Check program setting to make sure they are specific to the water quality and application needs
	c. Control valve regenerates frequently	c. Check for leaking fixtures that may be exhausting capacity or system is undersized
10. Residual regenerant being delivered to service	a. Low water pressure	a. Check incoming water pressure – water pressure must remain at minimum of 25 psi
	b. Incorrect injector size	b. Replace injector with correct size for the application
	c. Restricted drain line	c. Check drain line for restrictions or debris and clean
11. Excessive water in regenerant tank	a. Improper program settings	a. Check refill setting
	b. Plugged injector	b. Remove injector and clean or replace
	c. Drive cap assembly not tightened	c. Re-tighten the drive cap assembly
	d. Damaged seal/ stack assembly	d. Replace seal/ stack
	e. Restricted or kinked drain line	e. Check drain line for restrictions or debris and or un-kink drain line
	f. Plugged backwash flow controller	f. Remove backwash flow controller and clean or replace
	g. Missing refill flow controller	g. Replace refill flow controller
12. Control valve fails to draw in regenerant	a. Injector is plugged	a. Remove injector and clean or replace
	b. Faulty regenerant piston	b. Replace regenerant piston
	c. Regenerant line connection leak	c. Inspect regenerant line for air leak
	d. Drain line restriction or debris cause excess back pressure	d. Inspect drain line and clean to correct restriction
	e. Drain line too long or too high	e. Shorten length and or height
	f. Low water pressure	f. Check incoming water pressure – water pressure must remain at minimum of 25 psi
13. Water running to drain	a. Power outage during regeneration	a. Upon power being restored control will finish the remaining regeneration time. Reset time of day.
	b. Damaged seal/ stack assembly	b. Replace seal/ stack assembly
	c. Piston assembly failure	c. Replace piston assembly
	d. Drive cap assembly not tightened	d. Re-tighten the drive cap assembly

FILTER INSTALLATION AND USER GUIDE

Problem	Possible Cause	Solution
14. E1, Err – 1001, Err – 101 = Control unable to sense motor movement	a. Motor not inserted full to engage pinion, motor wires broken or disconnected	a. Disconnect power, make sure motor is fully engaged, check for broken wires, make sure two pin connector on motor is connected to the two pin connection on the PC Board labeled MOTOR. Press NEXT and REGEN buttons for 3 seconds to resynchronize software with piston position or disconnect power supply from PC Board for 5 seconds and then reconnect.
	b. PC Board not properly snapped into drive bracket	b. Properly snap PC Board into drive bracket and then Press NEXT and REGEN buttons for 3 seconds to resynchronize software with piston position or disconnect power supply from PC Board for 5 seconds and then reconnect.
	c. Missing reduction gears	c. Replace missing gears
15. E2, Err – 1002, Err – 102 = Control valve motor ran too short and was unable to find the next cycle position and stalled	a. Foreign material is lodged in control valve	a. Open up control valve and pull out piston assembly and seal/ stack assembly for inspection. Press NEXT and REGEN buttons for 3 seconds to resynchronize software with piston position or disconnect power supply from PC Board for 5 seconds and then reconnect.
	b. Mechanical binding	b. Check piston and seal/ stack assembly, check reduction gears, check drive bracket and main drive gear interface. Press NEXT and REGEN buttons for 3 seconds to resynchronize software with piston position or disconnect power supply from PC Board for 5 seconds and then reconnect.
	c. Main drive gear too tight	c. Loosen main drive gear. Press NEXT and REGEN buttons for 3 seconds to resynchronize software with piston position or disconnect power supply from PC Board for 5 seconds and then reconnect.
	d. Improper voltage being delivered to PC Board	d. Verify that proper voltage is being supplied. Press NEXT and REGEN buttons for 3 seconds to resynchronize software with piston position or disconnect power supply from PC Board for 5 seconds and then reconnect.
16. E3, Err – 1003, Err – 103 = Control valve motor ran too long and was unable to find the next cycle position	a. Motor failure during a regeneration	a. Check motor connections then Press NEXT and REGEN buttons for 3 seconds to resynchronize software with piston position or disconnect power supply from PC Board for 5 seconds and then reconnect.
	b. Foreign matter built up on piston and stack assemblies creating friction and drag enough to time out motor	b. Replace piston and stack assemblies. Press NEXT and REGEN buttons for 3 seconds to resynchronize software with piston position or disconnect power supply from PC Board for 5 seconds and then reconnect.
	c. Drive bracket not snapped in properly and out enough that reduction gears and drive gear do not interface	c. Snap drive bracket in properly then Press NEXT and REGEN buttons for 3 seconds to resynchronize software with piston position or disconnect power supply from PC Board for 5 seconds and then reconnect.

FILTER INSTALLATION AND USER GUIDE

Problem	Possible Cause	Solution
17. Err – 1004, Err – 104 = Control valve motor ran too long and timed out trying to reach home position	a. Drive bracket not snapped in properly and out enough that reduction gears and drive gear do not interface	a. Snap drive bracket in properly then Press NEXT and REGEN buttons for 3 seconds to resynchronize software with piston position or disconnect power supply from PC Board for 5 seconds and then reconnect.
18. Err -1006, Err – 106, Err - 116 = MAV/SEPS/ NHBP/ AUX MAV valve motor ran too long and unable to find the proper park position Motorized Alternating Valve = MAV Separate Source = SEPS No Hard Water Bypass = NHBP	a. Control valve programmed for ALT A or b, nHbP, SEPS, or AUX MAV without having a MAV or NHBP valve attached to operate that function	a. Press NEXT and REGEN buttons for 3 seconds to resynchronize software with piston position or disconnect power supply from PC Board for 5 seconds and then reconnect. Then re-program valve to proper setting.
	b. MAV/ NHBP motor wire not connected to PC Board	b. Connect MAV/ NHBP motor to PC Board two pin connection labeled DRIVE. Press NEXT and REGEN buttons for 3 seconds to resynchronize software with piston position or disconnect power supply from PC Board for 5 seconds and then reconnect.
	c. MAV/ NHBP motor not fully engaged with reduction gears	c. Properly insert motor into casing, do not force into casing Press NEXT and REGEN buttons for 3 seconds to resynchronize software with piston position or disconnect power supply from PC Board for 5 seconds and then reconnect.
	d. Foreign matter built up on piston and stack assemblies creating friction and drag enough to time out motor	d. Replace piston and stack assemblies. Press NEXT and REGEN buttons for 3 seconds to resynchronize software with piston position or disconnect power supply from PC Board for 5 seconds and then reconnect.
19. Err – 1007, Err – 107, Err - 117 = MAV/SEPS/ NHBP/ AUX MAV valve motor ran too short (stalled) while looking for proper park position Motorized Alternating Valve = MAV Separate Source = SEPS No Hard Water Bypass = NHBP Auxiliary MAV = AUX MAV	a. Foreign material is lodged in MAV/ NHBP valve	a. Open up MAV/ NHBP valve and check piston and seal/ stack assembly for foreign material. Press NEXT and REGEN buttons for 3 seconds to resynchronize software with piston position or disconnect power supply from PC Board for 5 seconds and then reconnect.
	b. Mechanical binding	b. Check piston and seal/ stack assembly, check reduction gears, drive gear interface, and check MAV/ NHBP black drive pinion on motor for being jammed into motor body. Press NEXT and REGEN buttons for 3 seconds to resynchronize software with piston position or disconnect power supply from PC Board for 5 seconds and then reconnect.

7) 5 YEAR WARRANTY

Commercial Simplex Backwashable Filter

Thank you for your purchase of our COMMERCIAL SIMPLEX BACKWASHABLE FILTER. For proof of purchase, please retain your Invoice/Sales Order Copy.

Warranty ~ Offered

Excalibur Water Systems warrants its products to be free from defect in materials and workmanship to the original owner from the date on the proof of purchase as described below.

Warranty ~ Working Procedures

If during the suitable warranty period, a part is defective, then Excalibur Water Systems will repair or replace that part at no charge to the original owner, with the exception of charges for nominal shipping, service and/or installation.

Warranty ~ Coverage Outlined

Excalibur Water Systems guarantees, to the original owner, a period of 5 years, the CONTROL BODY to be free of defects in materials and workmanship and to perform its proper functions. To the original owner, a period of 5 years, the ELECTRONIC CONTROL VALVES as well as all parts to be free of defects in materials and workmanship and to perform their normal functions. To the original owner, the SALT TANK and the MINERAL TANKS will not rust, corrode, leak, burst or in any other form fail to perform their proper functions for a period of 10 YEARS.

Warranty ~ Service

In the event you require service, Excalibur Water Systems Dealer will provide all necessary service and installation for your Duplex Commercial Water Filter. To obtain warranty service within 30 days of discovery of the defect, notification must be given to Excalibur Water Systems.

General Provisions

The above warranties are effective provided the WATER FILTER is operated at water pressures not exceeding 125psi and at water temperatures not exceeding 120°F; also provided that the water Filter is not subject to abuse, misuse, alteration, neglect, freezing, accident or negligence; and provided further that the water Filter is not damaged as the result of any unusual force of nature such as, but not limited to flood, hurricane, tornado or earthquake. Excalibur Water Systems is excused if failure to perform its warranty obligations is the result of strikes, government regulation, materials shortages or other circumstances beyond its control.

THERE ARE NO WARRANTIES ON THE WATER FILTER BEYOND THOSE SPECIFICALLY DESCRIBED ABOVE. ALL IMPLIED WARRANTIES, INCLUDING ANY IMPLIED WARRANTY OF MERCHANTABILITY OR OF FITNESS FOR A PARTICULAR PURPOSE, ARE DISCLAIMED TO THE EXTENT THEY MIGHT EXTEND BEYOND THE ABOVE PERIODS. THE SOLE OBLIGATION OF EXCALIBUR WATER SYSTEMS UNDER THESE WARRANTIES IS TO REPLACE OR REPAIR THE COMPONENT OR PART PROVES TO BE DEFECTIVE WITHIN THE SPECIFIED TIME PERIOD AND EXCALIBUR WATER SYSTEMS IS NOT LIABLE FOR CONSEQUENTIAL OR INCIDENTAL DAMAGES. NO DEALER, AGENT, REPRESENTATIVE OR OTHER PERSON IS AUTHORIZED TO EXTEND OR EXPAND THE WARRANTIES EXPRESSED ABOVE.

Certain provinces or states do not allow limitations on how long an implied warranty lasts or exclusions or limitations of incidental or consequential damage, therefore limitations and exclusions in this warranty may not apply to you. This warranty extends you specific legal rights as you may have other rights which vary from province to province or state to state.

Excalibur Water Systems is a manufacturer of water treatment products.

142 Commerce Park Drive

Barrie, Ontario Canada

