



Quality through innovation

1" PROGRESSIVE IRON SULPHUR MANGANESE INSTALLATION AND USER GUIDE

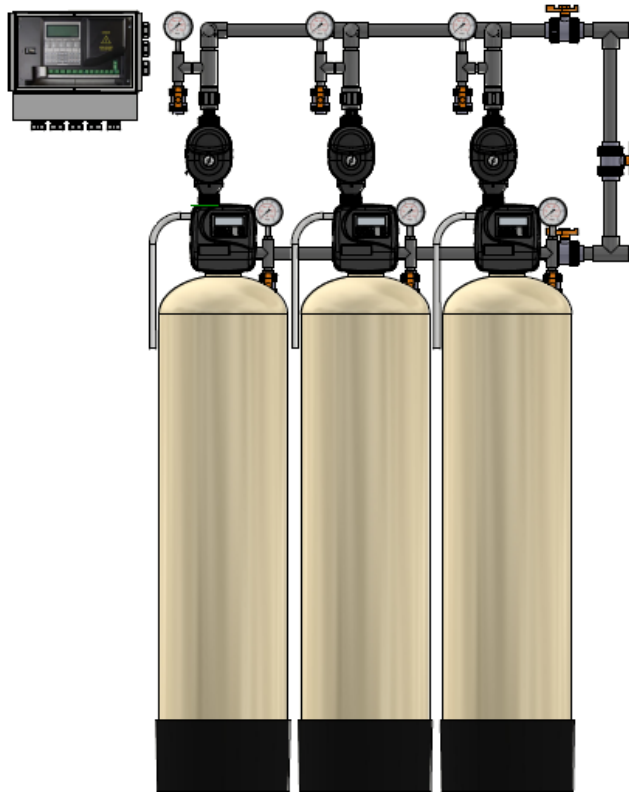

TABLE OF CONTENTS

- 1) Installation 3
 - 1.1) Pre-installation instructions..... 3
 - 1.2) General Installation and Service Warnings..... 3
 - 1.3) Site Requirements..... 3
 - 1.4) Installation Drawing..... 4
 - 1.5) System Drawing 5
 - 1.6) Plumbing 5
 - 1.7) Drain Line 6
 - 1.8) Bypass Valve..... 7
 - 1.9) Loading Instructions..... 8
 - 1.10) Start Up Instructions 9
- 2) Programming 10
 - 2.1) Regeneration and Error Screens 10
 - 2.2) Button Operation 10
 - 2.3) User Displays..... 12
 - 2.4) Setting Time of Day 13
 - 2.5) Configuration Settings 13
 - 2.6) Installer Display Settings..... 14
 - 2.7) Filter System Setup 15
 - 2.8) Diagnostics 16
- 3) System Controller Programming..... 19
 - 3.1) General Button Operation and Other Displays..... 19
 - 3.1) User Displays..... 20
 - 3.2) Set Time of Day and Day of Week..... 21
 - 3.3) System Setup Displays 22
 - 3.4) Configuration Displays 24
 - 3.5) Diagnostic Displays..... 25
 - 3.6) History Displays..... 26
 - 3.7) Data Extraction..... 27
 - 3.8) Flash Programming of System Controller 27
 - 3.9) Network Webpage Setup Procedure 27
 - 3.10) Network Configuration Displays 28

- 3.11) System Controller Programming Summary 29
- 4) Components of Control Valve 30
 - 4.1) Front Cover and PC Board 30
 - 4.2) Drive assembly, Piston and Spacer stack 31
 - 4.3) Injector Assembly 32
 - 4.4) Brine Tank Port 33
 - 4.5) Drain Line Flow Control Assembly 34
 - 4.6) Outlet Meter Port 35
 - 4.7) Bypass Valve Components 36
 - 4.8) Installation Fitting Assemblies 37
- 5) Quick Reference Guide 39
- 6) NO HARD WATER BYPASS (NHWB) 40
- 7) Service Instructions 41
 - 7.1) Front Cover Removal 41
 - 7.2) PC Board Removal 42
 - 7.3) Drive Bracket Removal 43
 - 7.4) Drive Cap Removal 44
 - 7.5) Piston Removal 45
 - 7.6) Stack Assembly Removal 46
- 8) Troubleshooting 47
 - 8.1) Possible Error Codes 47
 - 8.2) Troubleshooting Procedures 48
- 9) 5 Year Warranty 51

1) INSTALLATION

1.1) Pre-installation instructions

The cycle times, sequence of cycles and chemical removal capacity are preset to default by Excalibur. The installer must change the values according to the water test results, day override and time of regeneration. Set time of day, read normal operating displays, read power loss and error displays.

WATER TEST

Iron	_____	ppm
pH	_____	number
*Nitrates	_____	ppm
Manganese	_____	ppm
Sulphur	_____	yes/no
Total Dissolved Solids	_____	

1.2) General Installation and Service Warnings

- The filter is designed so that it can be installed easily with minor plumbing changes on previous plumbing.
- The piping must be clamped properly, and the weight of the plumbing must not be on the filter.
- Do not use any kind of lubricant including silicone. A silicone based lubricant can be only used on O- Rings but not necessary.
- The nuts and caps can be fastened and unfastened by hand or the plastic service wrench. Do not use pipe wrench to tighten the caps and nuts.

1.3) Site Requirements

- Water Pressure: - 40-110 psi
- Water Temperature: - 40-110°F (4.4-43°C)
- Electrical- 115/120 V, 60Hz Uninterrupted Outlet
- Current required is 0.5 Amperes
- The plug-in transformer is for dry locations only
- The tank should be on a firm level surface

1.4) Installation Drawing

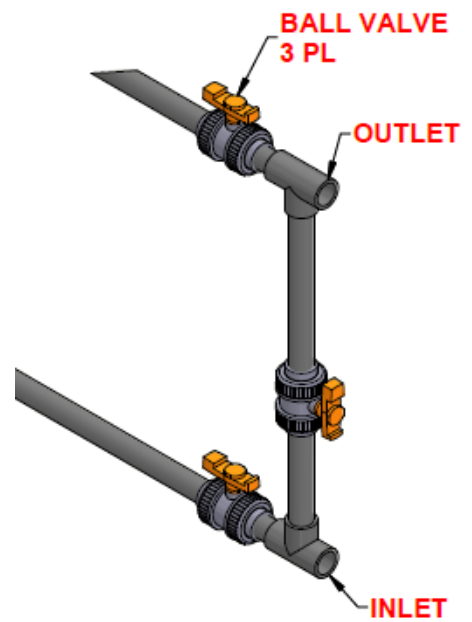
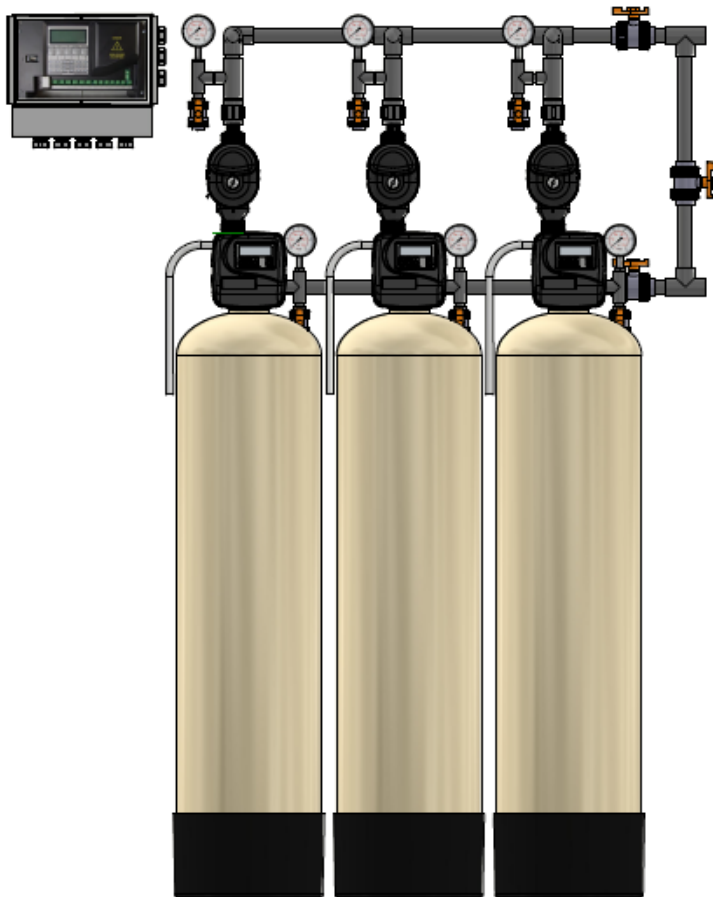
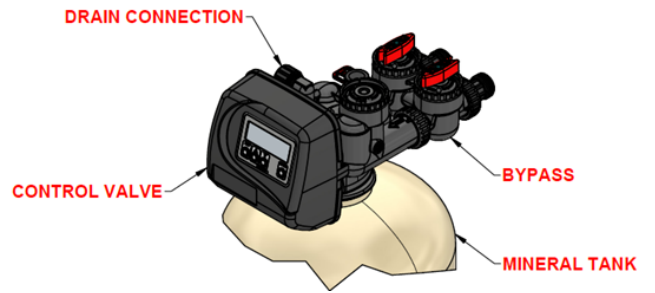
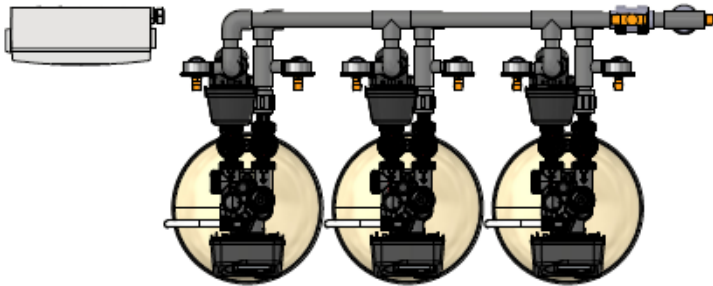

1.5) System Drawing

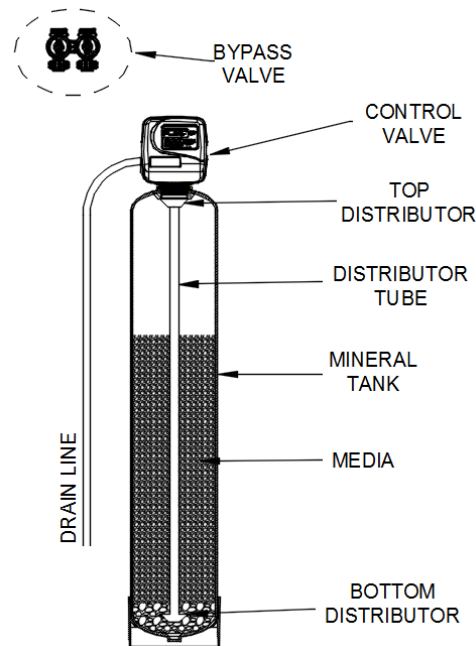

1.6) Plumbing

- The 3-way bypass valve must be installed.
- The filter must be close to drain as much as possible.
- The primer, solder or solder flux must not get on the O-rings.
- After soldering the lines must be cooled before installing the O-Rings, nuts and caps.
- If the electrical system is grounded to the plumbing than copper strap must be connected between inlet and outlet as shown in figure above.
- The plumbing must be done by following the local plumbing codes.
- The unit including the drain must be located in a room temperature above 33° F.
- Never let the vacuum occur in tank this may cause implosion and leakage. If vacuum occurrence is expected than vacuum breaker must be installed in line.

1.7) Drain Line

- The size of the drain line must be according to the model specifications.
- Leave minimum of 6" gap between flow control fitting and solder joints. The gap less than this can damage the flow control.
- Use 3/4" or 1" tubing for drain line according to the specifications.
- If the drain line is elevated and then emptied into the drain below the level the of control valve the 7" loop should make at the end of drain line.
- The air gap between the drain and the end of the drain line must be twice the diameter of the tube.
- The pipe must be clamped at the end to secure the line.

1.8) Bypass Valve

NORMAL OPERATION

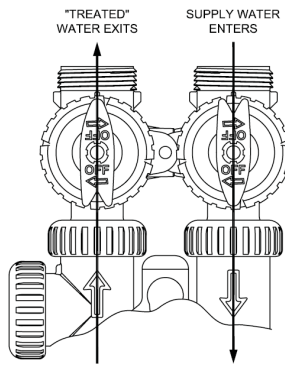

NORMAL OPERATION

The inlet and outlet handles of bypass valve should be pointing the direction of flow indicated by the engraved arrows on the control valve. Water flows through the control valve in normal operation as a water filter.

BYPASS OPERATION

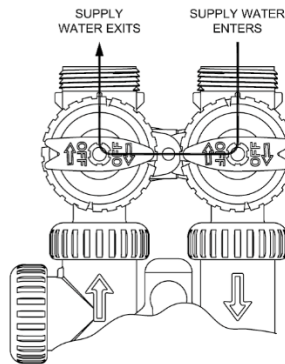

BYPASS OPERATION

The inlet and outlet handles point to the center of the bypass valve. The system is isolated from the water pressure in the plumbing system. Unfiltered water is supplied to the house in this position.

DIAGNOSTIC MODE

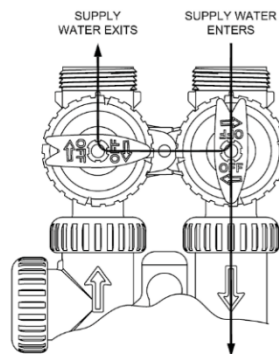

DIAGNOSTIC MODE

The inlet handle points in the direction of flow and the outlet handle points to the center of bypass valve, system water pressure is allowed to the control valve and the plumbing system while not allowing water to exit from the control valve to the plumbing. Unfiltered water is supplied to the house in this position.

SHUT OFF MODE

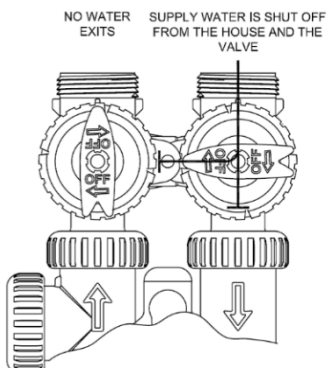

SHUT OFF MODE

The inlet handle points to the center of the bypass valve and the outlet handle points in the direction of flow, the water is shut off to the plumbing system. If water is available on the outlet side of the Filter, it is an indication of water bypass around the system.

1.9) Loading Instructions

Step 1: Check the product upon arrival and remove from box packaging checking for any shipping damage or shortages that must be reported to Excalibur Water Systems immediately for confirmation.

Step 2: Insert distributor(s) inside of media mineral tank(s) so it is positioned properly in the bottom centre groove. If not already sized properly cut the top of the distributor pipe $\frac{1}{2}$ - $\frac{3}{4}$ " above top of tank opening and clean off and excess PVC materials with grit cloth.

Step 3: Plug the top inlet opening of the distributor (Hub & Lateral) or bottom stack with a clean cloth, rag, or tape to prevent any gravel or resin from entering into the distributor tube.

Step 4: Load the gravel under bedding onto the mineral tank using a funnel or some sort of loading device. If multiple layers of gravel with different sizes being utilized always load the largest gravel size in diameter to the smallest last.

Step 5: Load the filtration media also using a funnel or some sort of loading device until all resin is inside of mineral tank.

Step 6: Remove top opening cover of the distributor carefully not to move or disturb the distributor tube not allowing any debris or materials to get inside of the now loaded filter(s).

Step 7: Thread on control valves onto top opening tanks be sure to check and verify that the O-ring on the bottom base of the control valve is present and properly lubricated with silicone. Tighten control valve(s) clockwise until you have reached the end of the thread and have secured a water tight seal. (If control valves that utilize quick connect collars thread the collars the same into the tanks then attach control valves).

Step 8: Precede now with the unit(s) in their proper installation locations to run piping and materials for all inlet, outlet, and drain connections properly with isolation valves and test ports for future water tests. Also unions should be included in installation materials for easy future servicing of the control valves when necessary on all inlet, outlet, and drain lines.

1.10) Start Up Instructions

- Keep the bypass valve in bypass operation by moving both handles pointing towards the center of bypass valve. Now the unfiltered water is being supplied to house. Open the faucet downstream of the filter until water comes clear out of it. The initial water can be dirty because of installation debris. Now inspect the leaks in plumbing.
- Press and hold the “UP” and “DOWN” buttons simultaneously for 3 seconds to start immediate manual regeneration. The drive motor will start to reach backwash cycle and countdown time begins (C1--). Turn the inlet bypass valve handle halfway into the direction of diagnose operation. Once the steady water flows out of drain then fully turn both handles of bypass valve into the direction of service operation.

Caution: - If water flow is too rapidly, there will be a loss of media to drain.

- When the water becomes clear in drain line then press the “UP” or “DOWN” button to advance the regeneration to rinse cycle (C4--). Allow this process for the full amount of time during the cycle.
- Once regeneration is finished the control valve will automatically come to the service position with the time of day or days to next regeneration being displayed.

2) PROGRAMMING

2.1) Regeneration and Error Screens



Regen Screen

Displays the time remaining in the current cycle. Pressing REGEN advances to the next cycle.

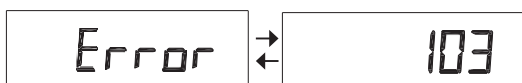

Error Screen

Alternated flashing Error and error code every 3 seconds. Clear by disconnecting the power supply at the PC board and reconnecting, or press NEXT and REGEN simultaneously for 3 seconds.

2.2) Button Operation



Scrolls to the next display.

REGEN

- Pressing once and releasing will schedule a regeneration at the preset delayed regeneration time.
- Pressing again and releasing will cancel the regeneration.
- Pressing and holding for 3 seconds will initiate an immediate regeneration
- Pressing while in regeneration will advance to the next cycle.
- Pressing in the program levels will go backwards to the previous screen



Change Variable being displayed.



Key sequence to lock and unlock program settings



Holding for 3 seconds initiates a control reset. The software version is displayed and the piston returns to the home/service position, resynchronizing the valve.

2.3) User Displays

When the system is operating, one of five displays may be shown. Pressing NEXT will alternate between the displays shown below.

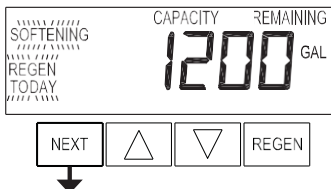

User 1

Typical user display. Shows volume remaining to regeneration. This screen will not be viewed if the control is set for time-clock operation.

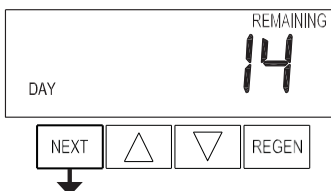

User 2

Displays number of days to next regeneration.



User 3

Flow Rate.
Displays present flow rate.

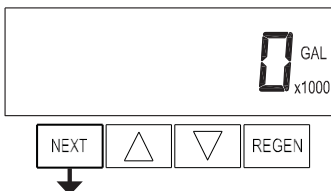

User 4

Displays total volume in gallons since last reset. If a meter is not used this display will be shown but 0 will be displayed.
PRESS ▼ FOR 3 SECONDS TO RESET TO 0.



User 5

Shows current time.

2.4) Setting Time of Day

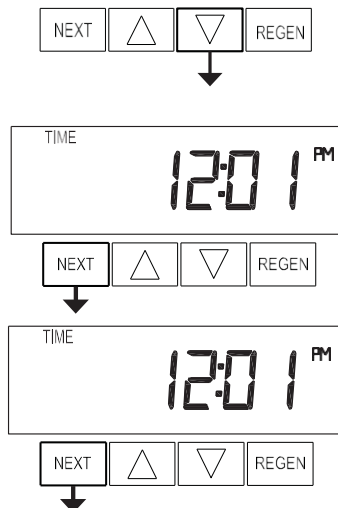

- Push NEXT button until time of day screen is displayed.
- Press and hold ▼ until SET TIME is displayed and the hour flashes once.
- Press ▲ or ▼ until the correct hour is displayed. Then press NEXT.
- The minutes will flash. Press ▲ or ▼ until the correct minute is displayed. Press NEXT to return to the User Displays.

If a power outage lasts less than 8 hours and the time of day flashes on and off, the battery should be replaced and the time should be reset.

2.5) Configuration Settings

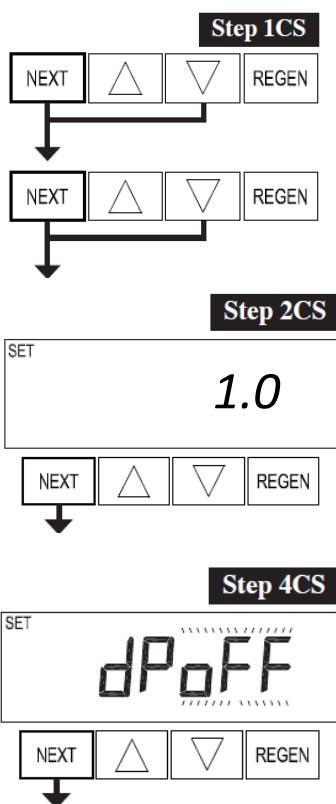

Step 1CS – Press NEXT and ▼ simultaneously for 5 seconds and release. Press NEXT and ▼ simultaneously for 5 seconds and release. If the screen in Step 2CS does not appear, the lock on the valve is activated. To unlock, press ▼, NEXT, ▲ and REGEN in sequence, then press NEXT and ▼ simultaneously for 5 seconds and release. Press NEXT and ▼ simultaneously for 5 seconds and release.

Step 2CS – Use ▲ or ▼ to select 1.0 for 1.0" valve. Press NEXT to go to Step 4CS. Press REGEN to exit Configuration Settings.

Step 4CS – Select dP OFF - outside regeneration signal feature not used, by using ▲ or ▼ buttons.

Press NEXT to go to Step 5CS. Press REGEN to return to previous step.

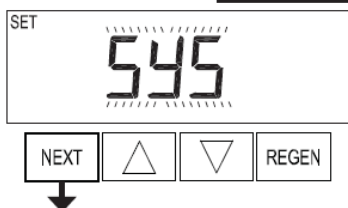
Step 5CS

RETURN TO NORMAL SCREENS

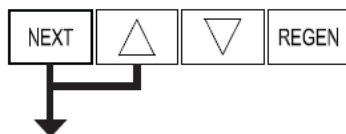
2.6) Installer Display Settings**Step 1I**

Step 1I - To enter Installer Display press NEXT and ▲ simultaneously for about 5 seconds and release.

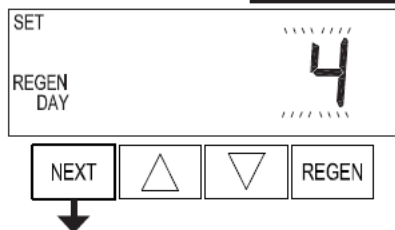
Step 2I

Step 2I – Day Override: Set “4” maximum number of days between regenerations using ▲ or ▼:
Press NEXT to go to step 4I. Press REGEN to return to previous step.

Step 3I

Step 3I – Next Regeneration Time (hour): Set the hour of day for regeneration using ▲ or ▼. The default time is 2:00.
Press NEXT to go to step 5I. Press REGEN to return to previous step.

Step 4I

Step 4I – Next Regeneration Time (minutes): Set the minutes of day for regeneration using ▲ or ▼.
Press NEXT to exit Installer Display Settings. Press REGEN to return to previous step.

Exit Installer Display Settings

Step 5CS – Select feature “SYS” using ▲ or ▼ buttons for filters.

Press NEXT to exit to Display Screens.
Press REGEN to return to previous step.

2.7) Filter System Setup



Step 1F - Press NEXT and ▼ simultaneously for 5 seconds and release.



Step 2F – Choose “FILTERING BACKWASH” using ▲ or ▼. Press NEXT to go to Step 3S. Press REGEN to exit OEM Filter System Setup.



Step 3F – Select the 10-minute time for the first/backwash cycle using ▲ or ▼. Press NEXT to go to Step 4F. Press REGEN to return to previous step.



Step 4F – Select the 8-minute time for second/fast rinse cycle using ▲ or ▼. Press NEXT to go to step 5F.



Step 5F – Set the regeneration trigger using ▲ or ▼ to adjust the number of gallons as per specifications of filter model.

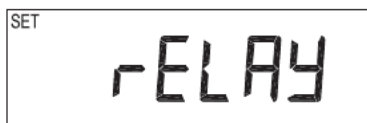

Step 6S – Select relay operation “oFF” using ▲ or ▼ buttons. Press NEXT to exit filter system setup.



2.8) Diagnostics



Step 8D

Step 8D – Volume, since last regeneration: This display shows the volume of water that has been filtered since the last regeneration. This display will equal zero when a water meter is not installed. Press NEXT to go to Step 9D. Press REGEN to return to previous step.

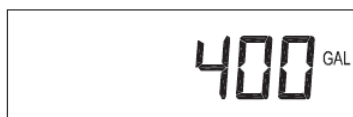
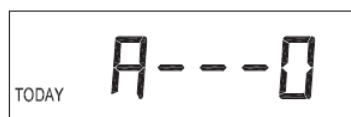
Step 9D

Step 9D – Volume, reserve capacity used for last 7 days. This display shows day 0 (for today) and flashes the reserve capacity. Pressing ▲ will show day 1 (which would be yesterday) and flashes the reserve capacity used. Pressing ▲ again will show day 2 (the day before yesterday) and the reserve capacity. Keep pressing ▲ to show the capacity for days 3, 4, 5 and 6. ▼ can be pressed to move backwards in the day series.

Press NEXT at any time to go to Step 10D. Press REGEN to return to previous step.

Step 10D

Step 10D – Volume, 63-day usage history: This display shows day 0 (for today) and flashes the volume of water filtered today. Pressing ▲ will show day 1 (which would be yesterday) and flashes the volume of water filtered on that day. Continue to press ▲ to show the maximum volume of water filtered for the last 63 days. If a regeneration occurred on the day the word “REGEN” will also be displayed. This display will show dashes if a water meter is not installed.

Press NEXT to exit Diagnostics. Press REGEN to return to previous step.

2.9) System Specifications

MODEL	MINERAL TANK SIZE	VESSEL MEDIA (ft ³)	FLOW RATES (GPM)	
			MINIMUM FLOW	BACKWASH
EWS FSC1N ^Z H2.5	13x54	2.5	1.0	13
EWS FSC1N ^Z H3	14x65	3.0	1.2	15
EWS FSC1N ^Z H4	16x65	4.0	1.6	20
EWS FSC1N ^Z H5	18x65	5.0	2.0	25

3) SYSTEM CONTROLLER PROGRAMMING

3.1) General Button Operation and Other Displays



Set clock from any user screen. Exit & save from setup or program screens.



Move to the next display



Used in initiating a manual regeneration. Moves back one display while in program mode.



Change variable being displayed

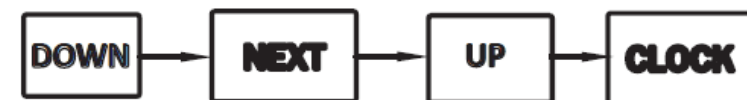

Key sequence to lock and unlock software

System Controller LED Functions

Blue LED (ONLINE): - Indicates which unit is the current “Lead” unit in the system. If the blue LED is flashing, then that Lead unit has lost communication with the system controller. The Blue LED will also transfer to the unit that has the least capacity remaining with RANDOM and SERIES system types.

Green LED (ONLINE): - Indicates which unit that is currently On-line in the system. If the green LED is flashing, then that unit has lost communication with the System Controller.

Orange LED (STANDBY): - Indicates which unit that is currently in Stand-by in the system. If the Orange LED is flashing, then that unit is detecting flow rate through this meter.

Red LED (REGEN): - Indicates which unit is currently in regeneration in the system. If the Red LED is flashing, then that unit is in error.

Green & Orange LED's: - Indicates that a unit is transferring between On-line and Stand-by.

Orange & Red (flashing) LED's: - Indicates that a unit is in error and the MAV / NHWBP valve is closed.

Green & Red (flashing) LED's: - Indicates that a unit is in error and the MAV / NHWBP valve is open.



After a flash reprogramming, select the US format to show 12 hour AM/PM timekeeping and Gallons for volume units.

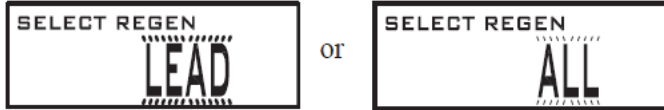

Press and hold Regen button. Use “UP” and “DOWN” button to select “LEAD” or “ALL”. Lead will regenerate the lead unit but all will regenerate all the unit in sequence. Press Next.

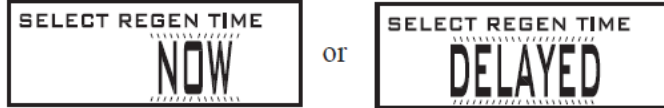

Use “UP” and “DOWN” button to select “NOW” or “DELAYED”. “Now” will regenerate immediately but delayed regenerated will occur at scheduled regeneration.

3.1) User Displays

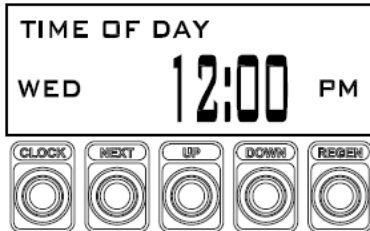

Displays Time of the day

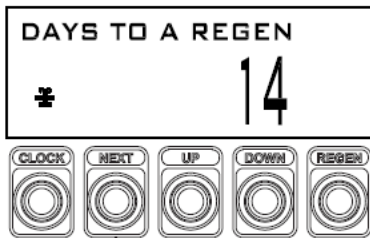

Displays the number of days between regeneration (* on the left signals the water flow)

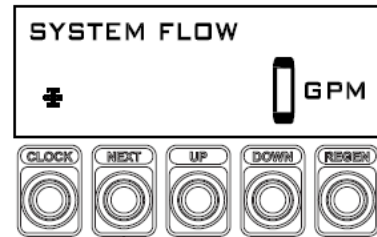

Displays the total system current flow rate

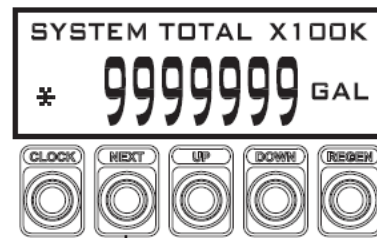

Displays the total flow in gallons since start up

3.2) Set Time of Day and Day of Week

STEP 1U

STEP 1U: - Press CLOCK.



STEP 2U

STEP 2U: - Current Time (hour): Set the hour using UP or DOWN buttons. Press NEXT to go to Step 3U. With metric units set, AM/PM indication will not appear and timekeeping will be shown in the 24-hour format.



STEP 3U

STEP 3U: - Current Time (minutes): - Set the minutes using the UP or DOWN buttons. Press NEXT to go to Step 4U.

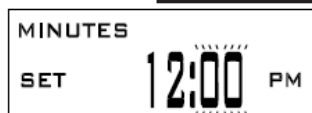

STEP 4U

STEP 4U: - Current day of the year: Set the year using the UP or DOWN buttons. Press NEXT to step 5U.



STEP 5U

STEP 5U: - Current Month: - Set the month using the UP or DOWN buttons. Press NEXT to step 6U.



STEP 6U

STEP 6U: - Current day of the month: - Set the day using the UP or DOWN buttons. Press NEXT to exit.



3.3) System Setup Displays

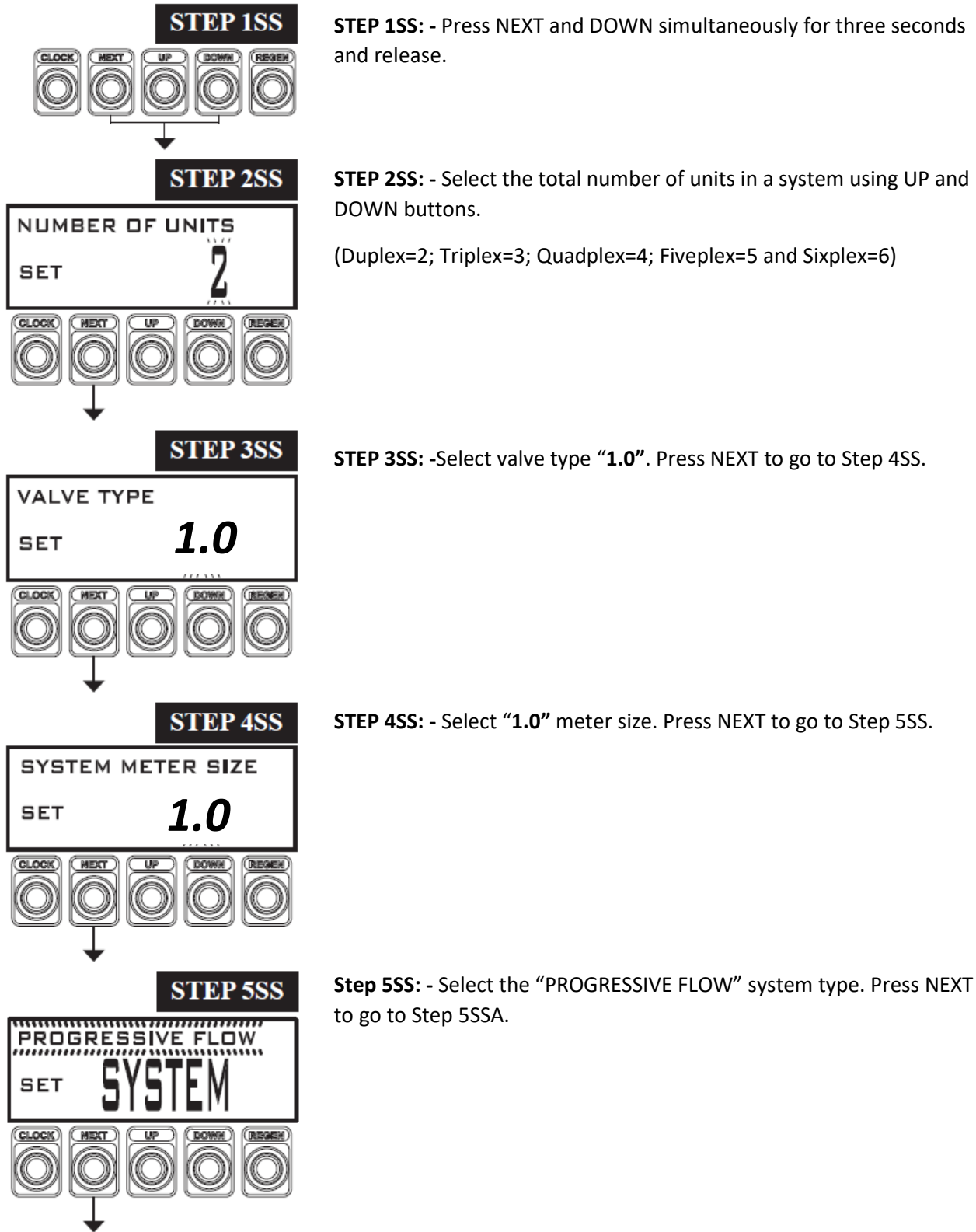

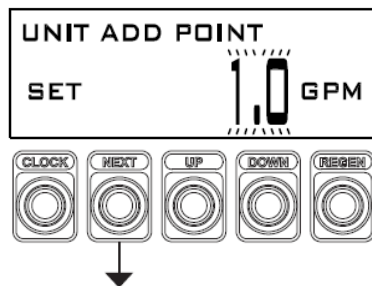
STEP 5SSA

Step 5SSA: - Adjust the unit add point in GPM as specified on the specifications of the system model. Press NEXT to go to Step 6SS.

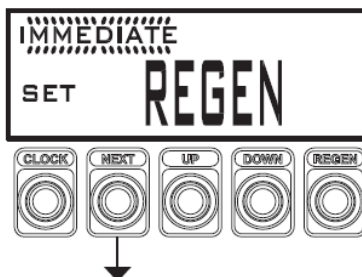
STEP 6SS

Step 6SS: - Set the regeneration to start "IMMEDIATE" when the capacity falls below reserve.

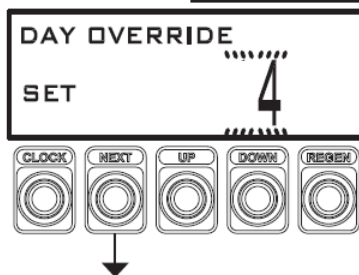
STEP 7SS

Step 7SS: - Set the maximum number of days to be "4" between regenerations.

RETURN TO NORMAL MODE

3.4) Configuration Displays

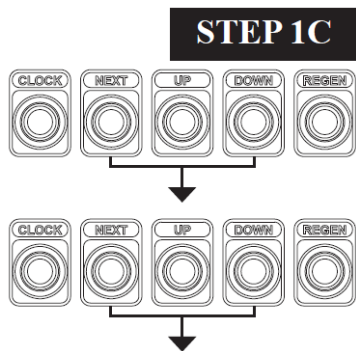

STEP 1C

STEP 1C: - Press NEXT and DOWN simultaneously for approximately three seconds, then release. Press NEXT and DOWN again simultaneously for 3 seconds and release.

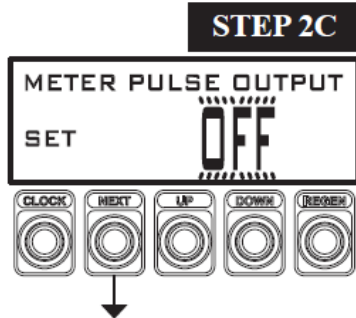

STEP 2C

STEP 2C: - Set "OFF" Meter Pulse Output operation using UP or DOWN.

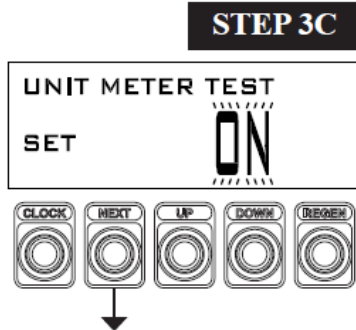

STEP 3C

STEP 3C: - Set Unit Meter Test "ON" using UP or DOWN. Press NEXT to go to Step 4C.

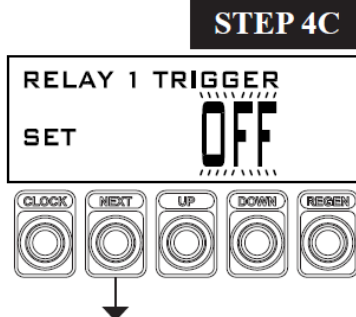

STEP 4C

STEP 4C: - Set Relay 1 trigger "OFF" using UP or DOWN buttons. Press NEXT to go to Step 5C.

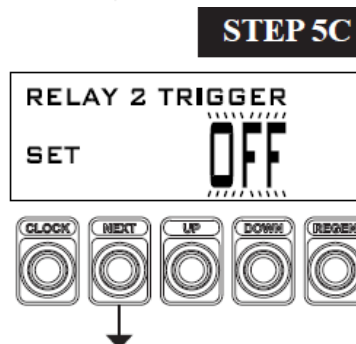

STEP 5C

STEP 5C: - Set Relay 2 Trigger "OFF" using UP or DOWN. Press NEXT to exit configuration displays.

Press NEXT to save and exit to normal mode.

3.5) Diagnostic Displays

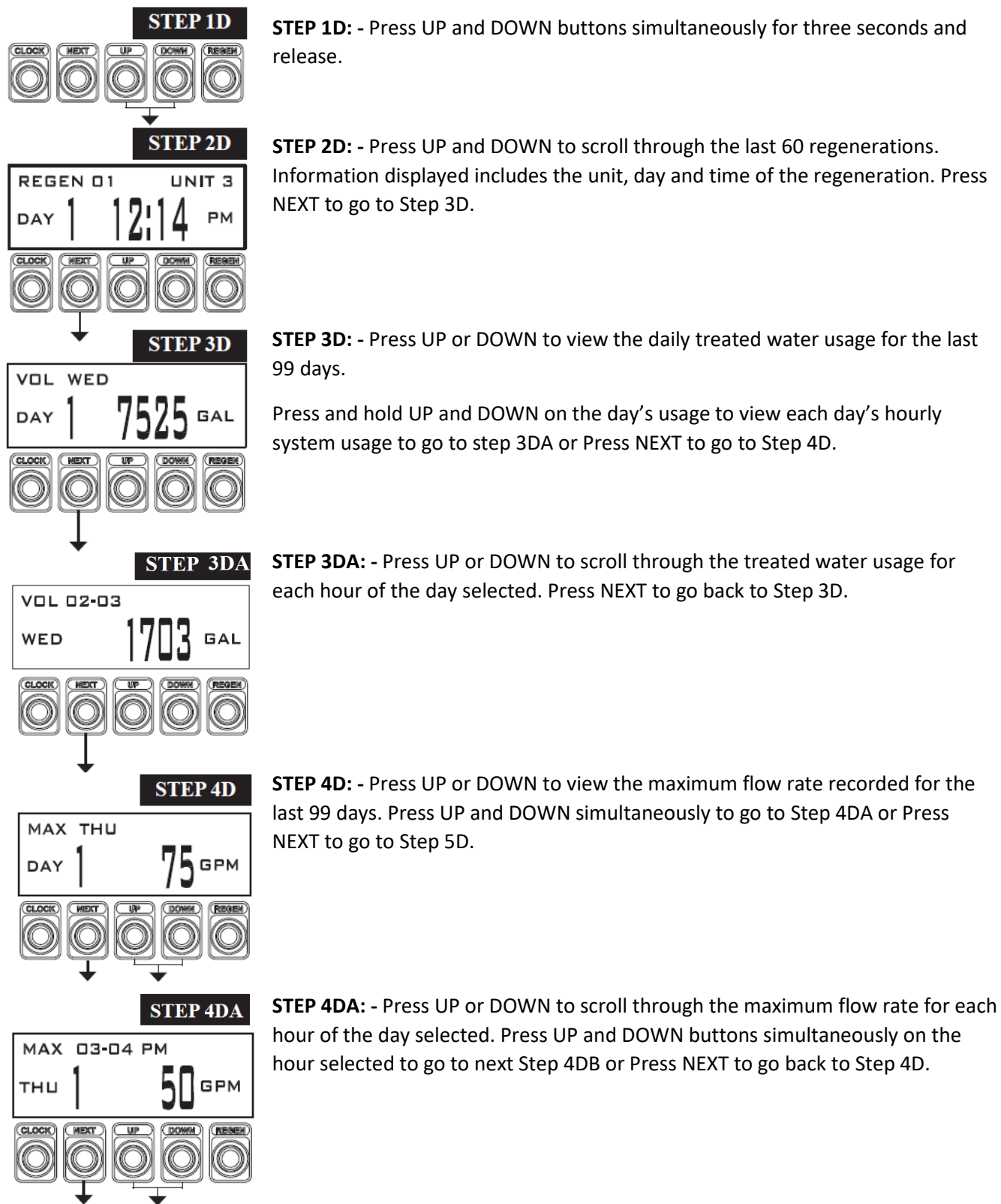

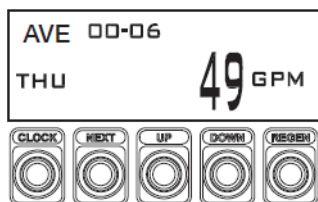
STEP 4DB

STEP 4DB: - Press UP or DOWN to scroll through the average system flow rate for the selected hour, in 6-minute interval. Press NEXT to return to Step 4DA.

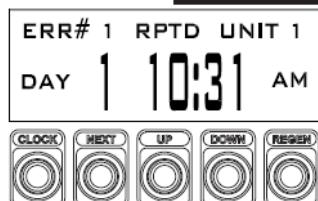
STEP 5D

STEP 5D: - This display shows the error log with last 20 valve errors and communication losses are stored in it. Use UP and DOWN buttons to scroll through the log.

DAY XX = Indicates the number of days ago

COM- = Communication lost error

RPTD = Indicates the valve error was not reset

CLRD = Indicates the valve error was finally reset

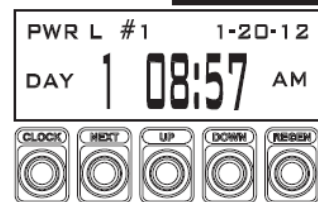
STEP 6D

STEP 6D: - Press UP or DOWN to view the last 20 power events. Press NEXT to exit Diagnostics. Press REGEN to return to previous step.

3.6) History Displays

STEP 1HD

STEP 1HD: - Press UP and DOWN simultaneously for three seconds and release. Again press UP and DOWN buttons simultaneously for three seconds and release.

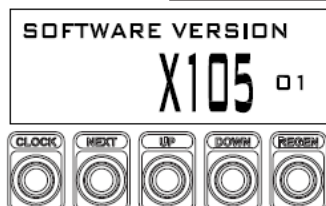
**STEP 2HD**

STEP 2HD: - Displays software rev level. Press NEXT to go to Step 3HD.

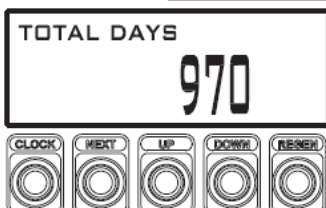
STEP 3HD

STEP 3HD: - Displays total days since startup. Press NEXT to exit to normal model.

3.7) Data Extraction

Step 1: - Ensure the USB memory device is formatted for FAT32 file system and that the allocation unit size is set for 4096 bytes.

Step 2: - Ensure that the System Controller is powered on.

Step 3: - Plug the USB memory device into the System Controller USB port.

Step 4: - During the extraction process, a series of status displays will appear. When the “USB COMPLETE” message appears, remove the USB device from the System Controller. This could take several minutes.



Step 5: - The extracted data can then be imported into the Clack Data Extraction spreadsheet.

3.8) Flash Programming of System Controller

Step 1: - Ensure the USB memory device is formatted for the FAT32 file system. If not, consult the manufacturer of the USB memory device for the latest in formatting instructions.

Step 2: - Ensure that System Controller is switched off.

Step 3: - Plug the USB memory device into the System Controller USB port.

Step 4: - Apply power to the System Controller.

Step 5: - The LCD backlight will appear blue which means working. The LCD will show no characters and all LED's will remain off for the duration of programming. When the LCD turns green, the process is complete and successful.

Step 6: - Remove the power from the System Controller.

Step 7: - Remove the USB memory device from the System Controller.

Step 8: - Reapply power to the System Controller. Normal functionality should be present.

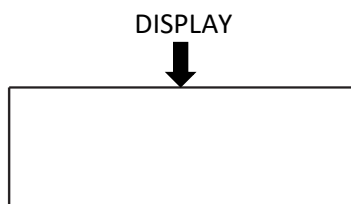

Flash Reprogramming Status Display

Blue Display = Control is being reprogrammed

Green Display = Control has been reprogrammed

Red Display = An error occurred during control reprogramming, and the reprogramming process has failed

3.9) Network Webpage Setup Procedure

Step 1: - Open the WEB.zip file.

Step 2: - Copy the “Web” folder to a USB memory device.

Step 3: - Ensure that the System Controller is powered on.

Step 4: - Plug the USB memory device into the System Controller USB port.

Step 5: - During the network web page setup process, a series of status displays will appear. When the “USB COMPLETE” message appears, remove the USB device from the System Controller.



3.10) Network Configuration Displays

STEP 1NS



STEP 1NS: - Press NEXT and DOWN buttons simultaneously and release after 3 seconds. Repeat this step for another two times.

STEP 2NS



STEP 2NS: - Set the desired Host Name to identify this controller on the network. Pressing CLOCK will select the first letter, use UP or DOWN to change each letter. Press NEXT to forward to the next character. Press NEXT to go to Step 3NS. Press REGEN to go to previous character or step.

STEP 3NS

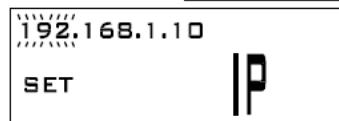

STEP 3NS: - IP Addressing – Set the proper static IP address. Each IP address has four sections separated by decimal points. Pressing CLOCK will select the first section of the address to be changed. Press UP or DOWN to adjust each section, using NEXT to advance to the next section and to Step 4NS.

STEP 4NS

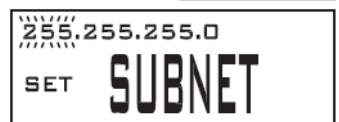

STEP 4NS: - Subnet Masking – Set the proper Subnet Mask. Each Subnet Mask has four sections separated by decimal points. The System Controller will only be able to communicate with other devices within the same subnet. Pressing CLOCK will select the first section of the address to be changed by pressing UP or DOWN buttons to adjust each section. Pressing NEXT will advance to the next section and to the Step 5NS.

STEP 5NS



STEP 5NS: - MAC address – The controller's unique ID code that is set at the factory. This information is read-only for information purposes. Press NEXT to exit Network Configuration. Press REGEN to return to the previous step.

3.11) System Controller Programming Summary

System Setup		
Step #	Value	Description
2SS	2,3,4,5 or 6	Number of Units in System
3SS	1.0	1" Control Valves
4SS	1.0	1" Meter Size
5SS	PROGRESSIVE	All units online only one can regenerate at a time
6SS	IMMEDIATE REGEN	Regen starts immediately without delay
7SS	4	Maximum number of days between regeneration

Configuration Settings		
Step #	Value	Description
2C	OFF	Meter Output
3C	ON	Meter Logic Test
4C	OFF	Relay 1 will always be off
5C	OFF	Relay 2 will always be off

Network Configuration Settings		
Step #	Value	Description
2NS	SYSTEM CONTROLLER	Name of System Controller on network
3NS	XXX.XXX.X.XX	Set Proper Static IP address
4NS	XXX.XXX.XXX.X	Set Proper Subnet Masking
5NS	04.81.AE.00.00.00	Unique MAC Address

4) COMPONENTS OF CONTROL VALVE

4.1) Front Cover and PC Board

Drawing No.	Order No.	Description	Quantity
1	CLK V3175TC01	WS1TC FRONT COVER ASY	1
2	CLK V310701	WS1 MOTOR ASY	1
3	CLK 310601	WS1 DRIVE BRACKET & SPRING CLIP	1
4	CLK V3818TC	WS1TC PC BOARD 4-DIGIT	1
5	CLK V3110	WS1 DRIVE REDUCING GEAR 12 X 36	3
6	CLK V3109	WS1 DRIVE GEAR COVER	1
Not Shown	CLK V3186	WS1 AC ADAPTER 120V-12V	1
	CLK V3186EU	WS1 AC ADAPTER 220-240V-12V EU	
	CLK V3186UK	WS1 AC ADAPTER 220-240V-12V UK	
	CLK V318601	WS1 AC ADAPTER CORD ONLY	

Battery Fully Seated

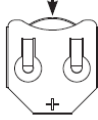

Battery Orientation

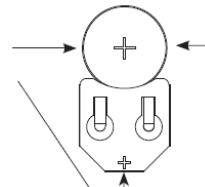

Replacement battery type 2032

AC Adapter	U.S.
Supply Voltage	120 V AC
Supply	60 Hz
Output Voltage	12 V AC
Output Current	500 mA

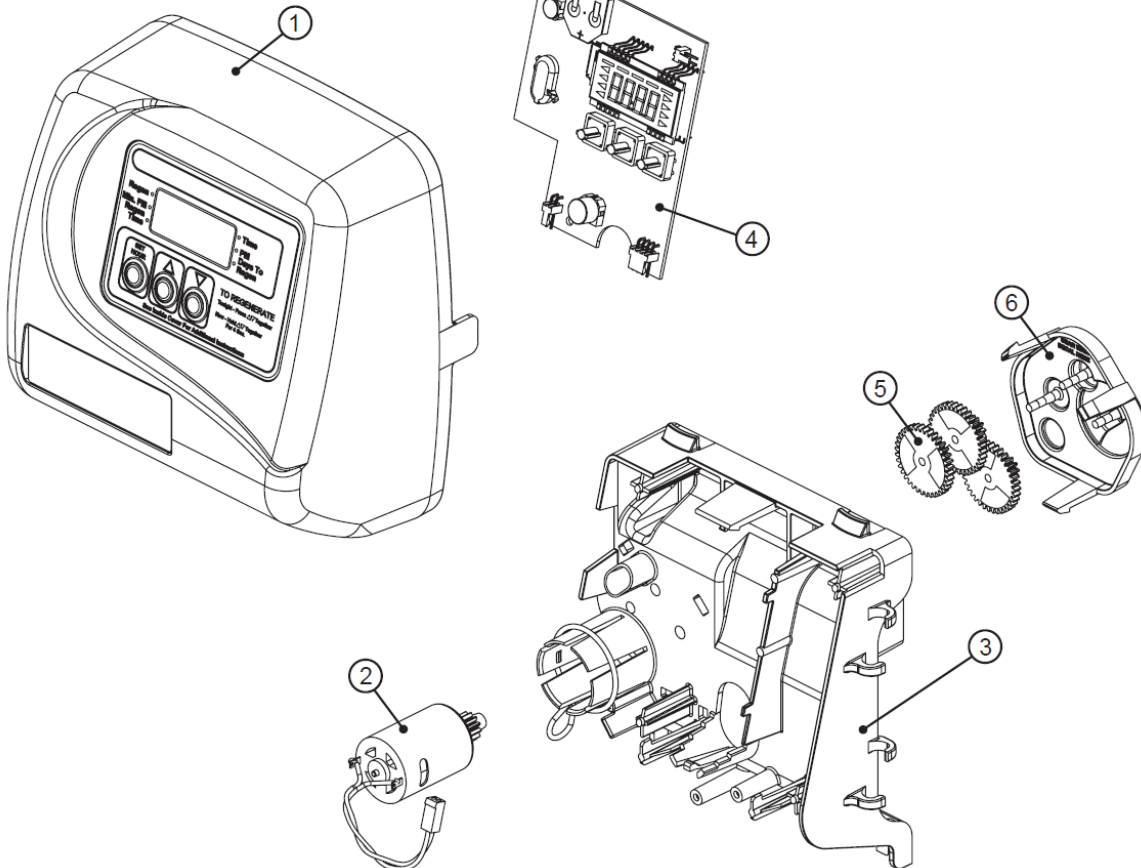

4.2) Drive assembly, Piston and Spacer stack

Drawing No.	Order No.	Description	Quantity
1	CLK V3005	WS1 Spacer Stack Assembly	1
2	CLK V3004	Drive Cap ASY	1
3	CLK V3178	WS1 Drive Back Plate	1
4	CLK V3011	WS1 Piston Downflow ASY	1
5	CLK V3135	O-ring 228	1
6	CLK V3180	O-ring 337	1
7	CLK V3105	O-ring 215 (Distributor Tube)	1
Not Shown	CLK V3001	WS1 Body ASY Downflow	1

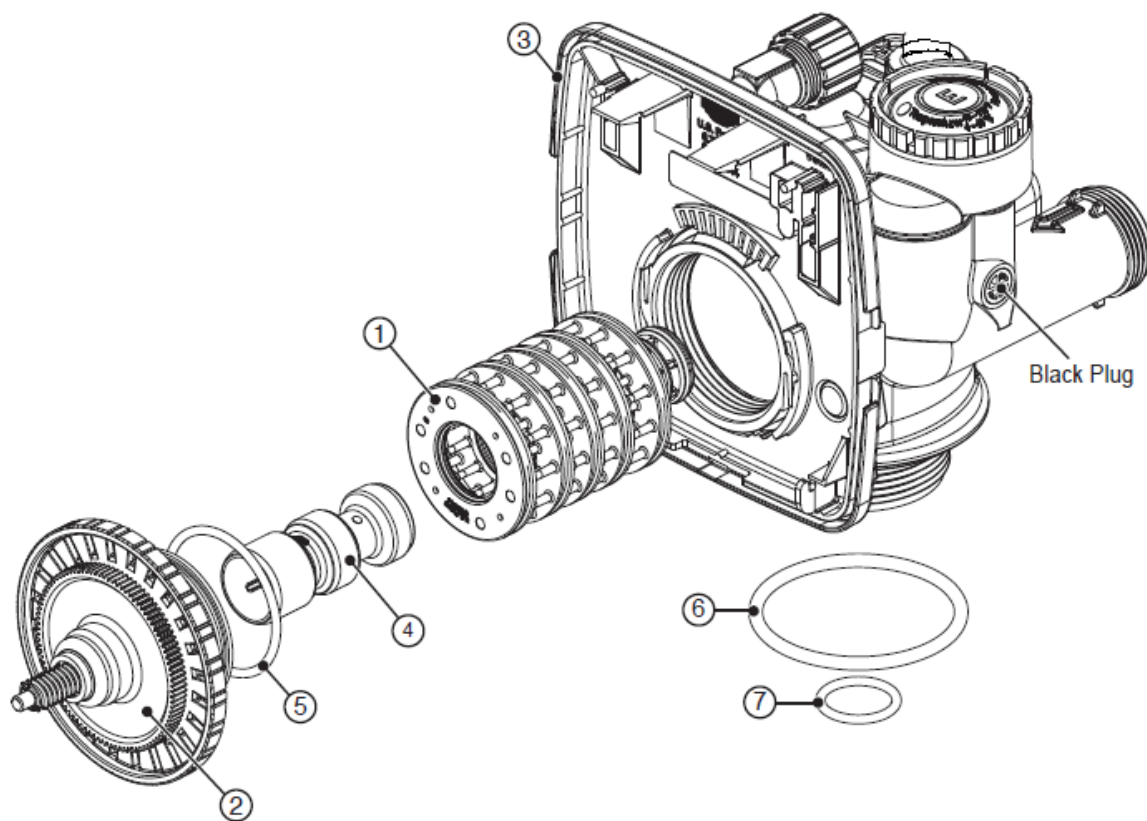

4.3) Injector Assembly

Drawing No.	Order No.	Description	Quantity
1	CLK V3176	INJECTOR CAP	1
2	CLK V3152	O-RING 135	1
3	CLK V30101Z	WS1 INJECTOR ASY Z PLUG	1
Not Shown*	CLK V3170	O-RING 011	1
Not Shown*	CLK V3171	O-RING 013	1

* The injector plug and the injector each contain 011 (lower) and 013 (upper) O-ring.

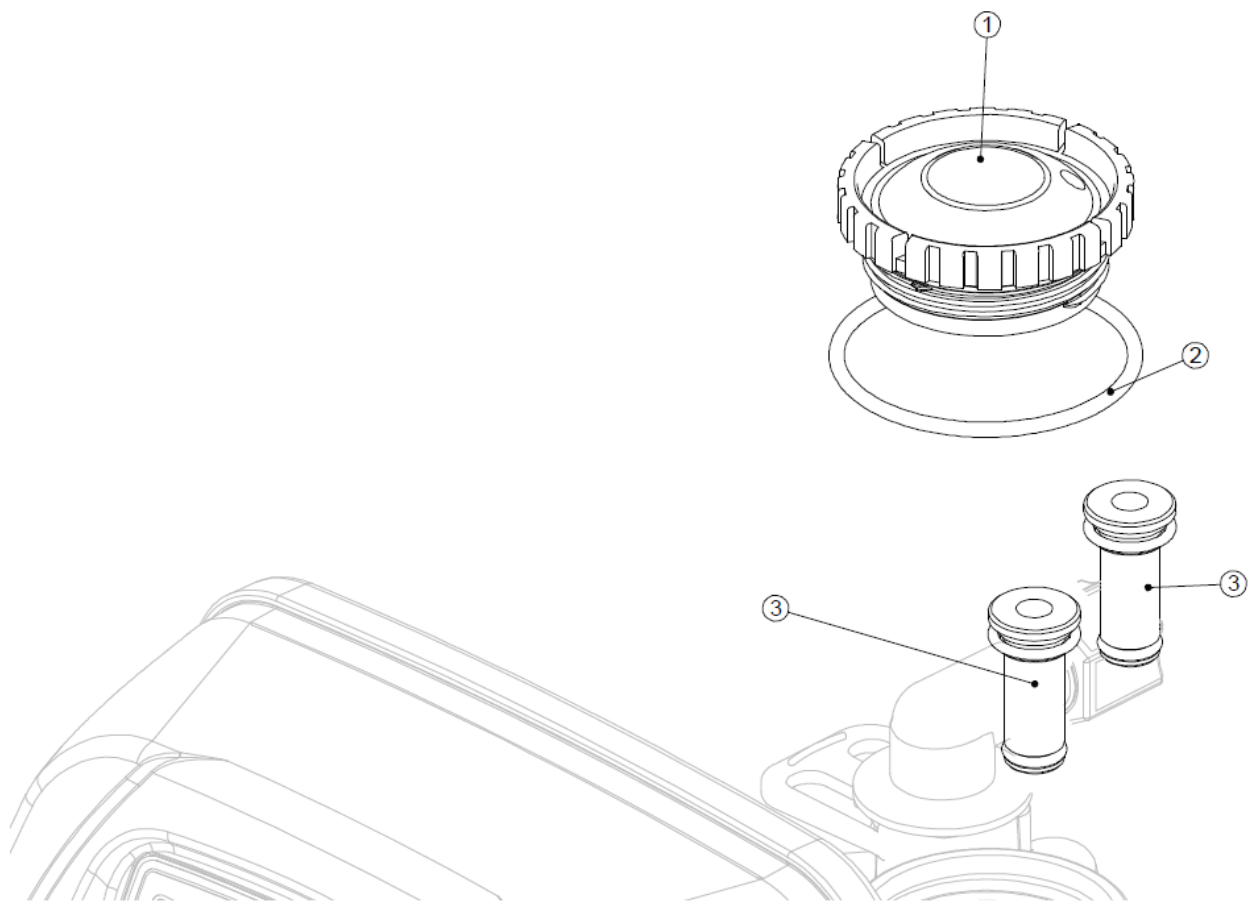

4.4) Brine Tank Port

Drawing No.	Order No.	Description	Quantity
1	CLK V319501	WS1 Refill Port Plug Asy	1
2	CLK H4615	Elbow Locking Clip	1

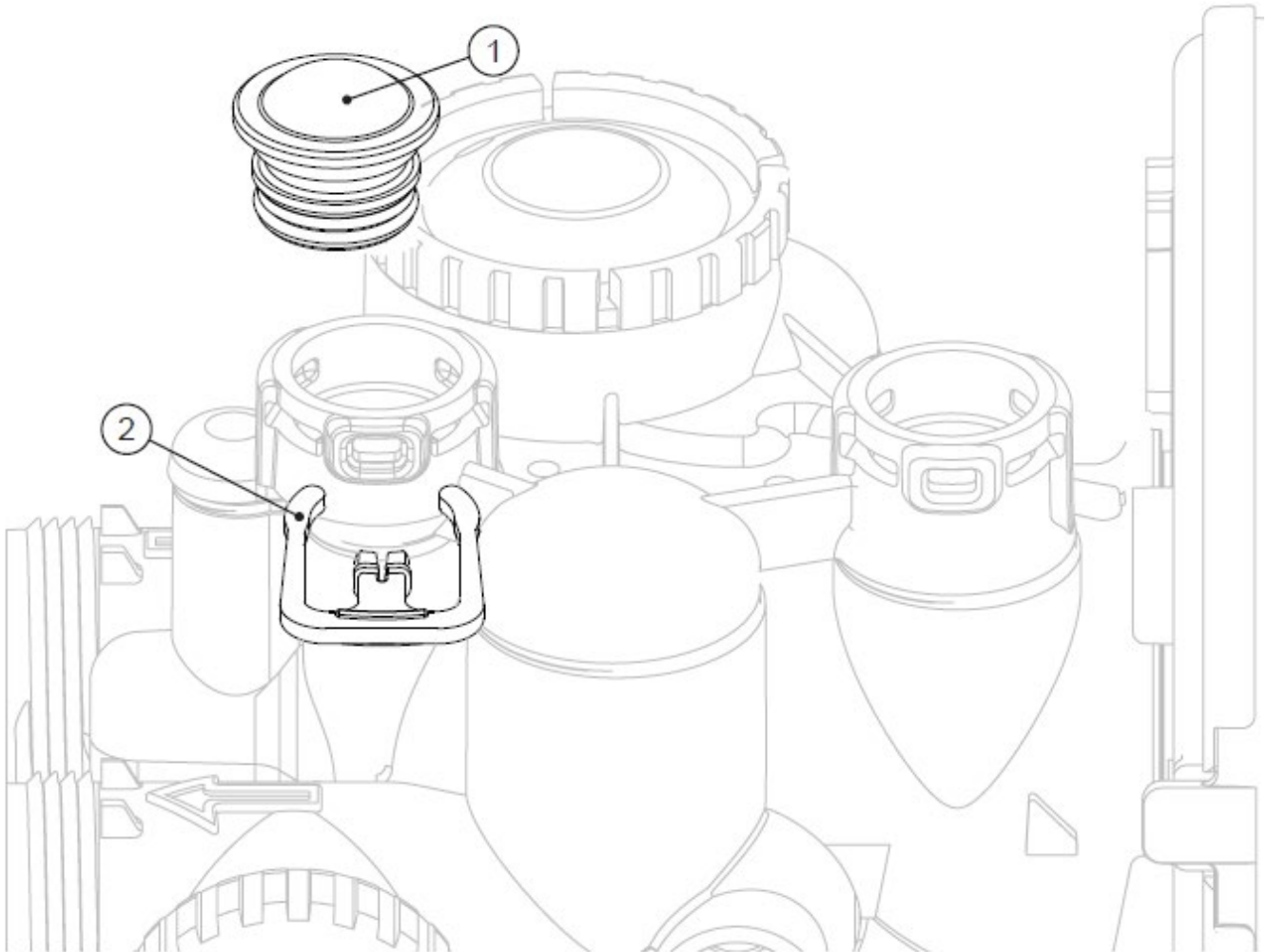

4.5) Drain Line Flow Control Assembly

Drain Line 3/4"			
Drawing No.	Order No.	Description	Quantity
1	CLK H4615	Elbow Locking Clip	1
2	CLK PKP10TS8BU	Polytube insert 5/8	Option
3	CLK V3192	WS1 Nut 3/4 Drain Elbow	Option
4	CLK V315801	WS1 Drain Elbow 3/4 Male	1
	CLK V315802	WS1 Drain Elbow 3/4 Male No	
5	CLK V3163	O-ring 019	1
6	CLK V315901	WS1 DLFC Retainer ASY	1
7	CLK V3162053	WS1 DLFC 5.3 gpm	1

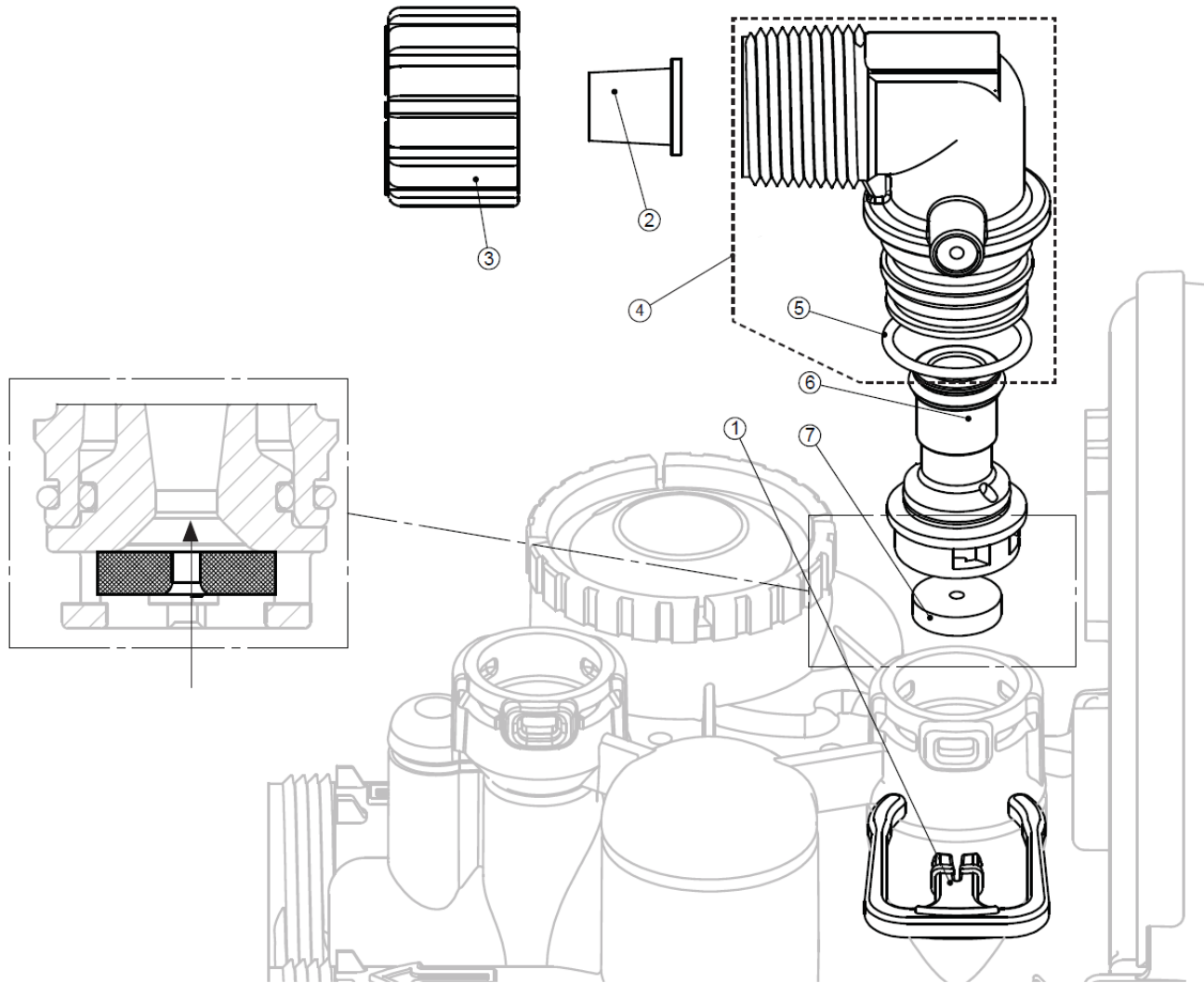

4.6) Outlet Meter Port

Drawing No.	Order No.	Description	Quantity
1	CLK V3151	WS1 Nut 1" QC	1
2	CLK V300301	WS1 Meter Plug ASY	1
3	CLK V3105	O-ring 215	1

* CLK V3003 includes CLK V311801 and CLK V3105

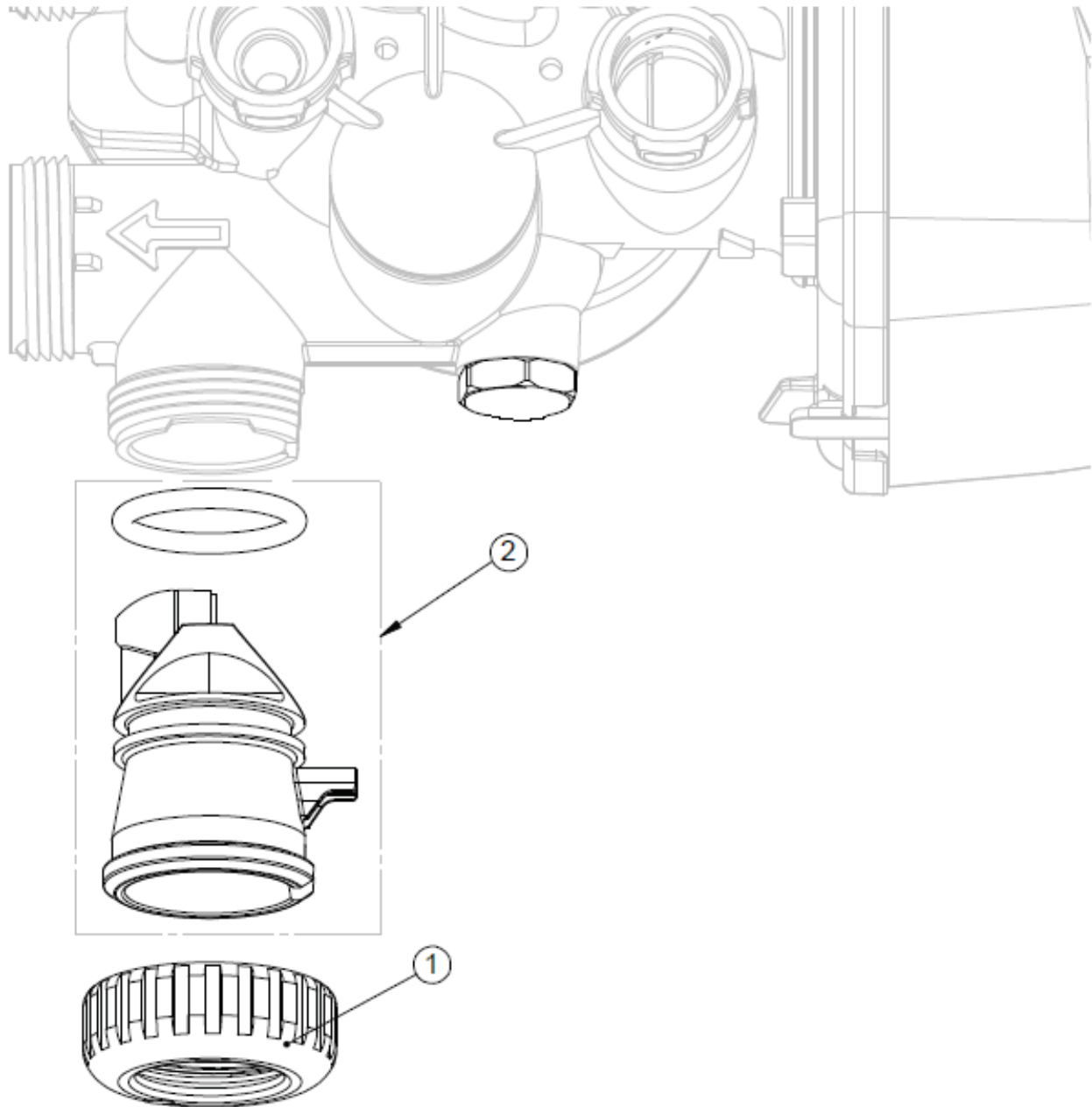

4.7) Bypass Valve Components

CLK V3006		WS1 Bypass Valve Assembly	
Drawing No.	Order No.	Description	Quantity
1	CLK V3151	WS1 Nut 1" Quick Connect	2
2	CLK V3150	WS1 Split Ring	2
3	CLK V3105	O-Ring 215	2
4	CLK V3145	WS1 Bypass 1" Rotor	2
5	CLK V3146	WS1 Bypass Cap	2
6	CLK V3147	WS1 Bypass Handle	2
7	CLK V3148	WS1 Bypass Rotor Seal	2
8	CLK V3152	O-ring 135	2
9	CLK V3155	O-ring 112	2
10	CLK V3156	O-ring 214	2

CLK V319101	WS1 Bypass Vertical Asy Adapter	
Order No.	Description	Qty
CLK V3151	WS1 Nut 1" Quick Connect	2
CLK V3150	WS1 Split Ring	2
CLK V3105	O-Ring 215	2
CLK V3191	WS1 Bypass Vertical	2

*Bypass Valve Vertical Adapter not shown in drawing

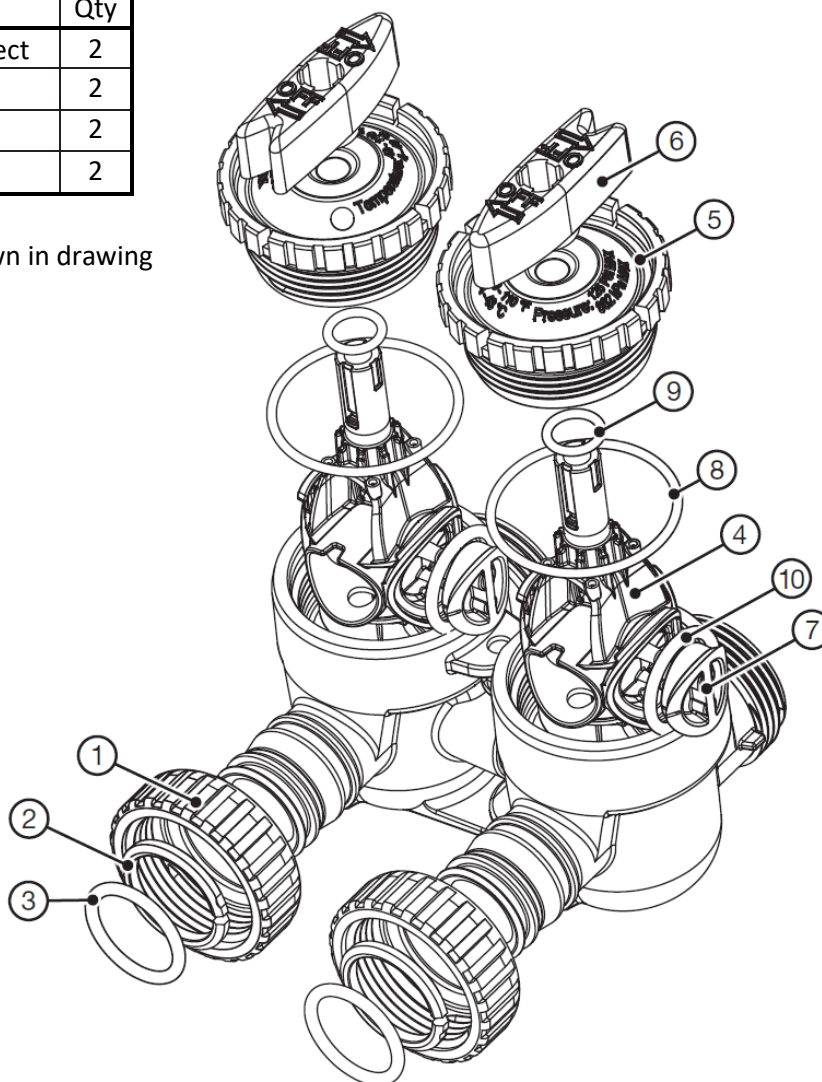

4.8) Installation Fitting Assemblies

CLK V3007 WS1 Fitting 1" PVC Male NPT Elbow Assembly			
Drawing No.	Order No.	Description	Quantity
1	CLK V3151	WS1 NUT 1" QUICK CONNECT	2
2	CLK V3150	WS1 SPLIT RING	2
3	CLK V3105	O-RING 215	2
4	CLK V3149	WS1 FITTING 1 PVC MALE NPT	2

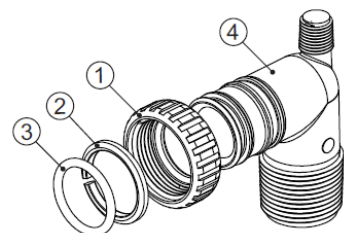

CLK V300701 WS1 Fitting 3/4" & 1" PVC Solvent 90° Assembly			
Drawing No.	Order No.	Description	Quantity
1	CLK V3151	WS1 NUT 1" QUICK CONNECT	2
2	CLK V3150	WS1 SPLIT RING	2
3	CLK V3105	O-RING 215	2
4	CLK V3189	WS1 FITTING 3/4 & 1 PVC SOLVENT 90	2

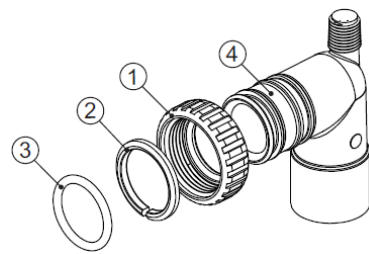

CLK V300702LF WS1 Fitting 1" Brass Sweat Assembly LF			
Drawing No.	Order No.	Description	Qty
1	CLK V3151	WS1 NUT 1" QUICK CONNECT	2
2	CLK V3150	WS1 SPLIT RING	2
3	CLK V3105	O-RING 215	2
4	CLK V3188LF	WS1 FITTING 1 BRASS SWEAT ASSEMBLY LF	2

Do not install in California.

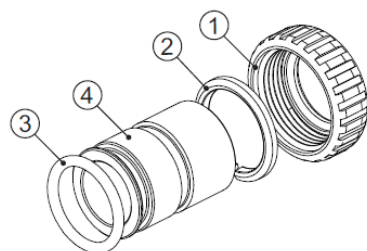

CLK V300703LF WS1 Fitting 3/4" Brass Sweat Assembly LF			
Drawing No.	Order No.	Description	Quantity
1	CLK V3151	WS1 NUT 1" QUICK CONNECT	2
2	CLK V3150	WS1 SPLIT RING	2
3	CLK V3105	O-RING 215	2
4	CLK V318801LF	WS1 FITTING 3/4 BRASS SWEAT LF	2

Do not install in California.

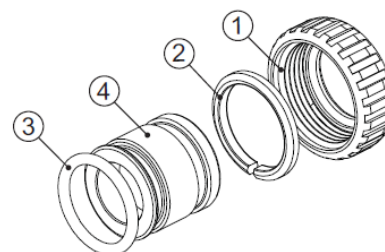

CLK V300704 WS1 Fitting 1" Plastic Male NPT Assembly			
Drawing No.	Order No.	Description	Quantity
1	CLK V3151	WS1 NUT 1" QUICK CONNECT	2
2	CLK V3150	WS1 SPLIT RING	2
3	CLK V3105	O-RING 215	2
4	CLK V3164	WS1 FITTING 1" PLASTIC MALE NPT	2

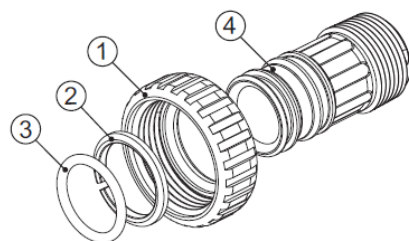

FILTER INSTALLATION AND USER GUIDE

CLK V300705 WS1 Fitting 1-1/4" Plastic Male NPT Assembly			
Drawing No.	Order No.	Description	Quantity
1	CLK V3151	WS1 NUT 1" QUICK CONNECT	2
2	CLK V3150	WS1 SPLIT RING	2
3	CLK V3105	O-RING 215	2
4	CLK V3317	WS1 FITTING 1-1/4" PLASTIC MALE NPT	2

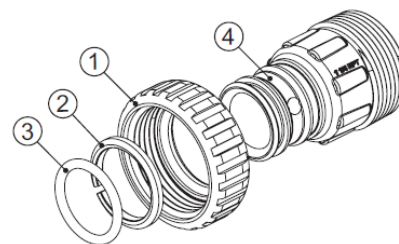

CLK V300709LF WS1 Fitting 1-1/4" & 1-1/2" Brass Sweat Assembly LF			
Drawing No.	Order No.	Description	Quantity
1	CLK V3151	WS1 NUT 1" QUICK CONNECT	2
2	CLK V3150	WS1 SPLIT RING	2
3	CLK V3105	O-RING 215	2
4	CLK V3375LF	WS1 FITTING 1-1/4" & 1-1/2" BRASS	2

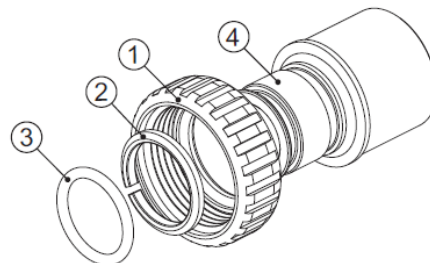

CLK V300712LF WS1 Fitting 3/4" Brass SharkBite Assembly LF			
Drawing No.	Order No.	Description	Quantity
1	CLK V3151	WS1 NUT 1" QUICK CONNECT	2
2	CLK V3150	WS1 SPLIT RING	2
3	CLK V3105	O-RING 215	2
4	CLK V3628LF	WS1 FTG 3/4 BRASS SHARKBITE LF	2

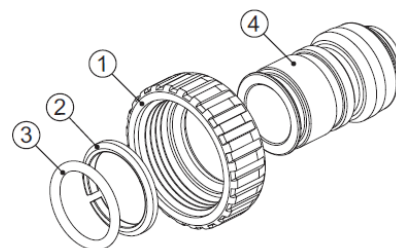

CLK V300713LF WS1 Fitting 1" Brass SharkBite Assembly LF			
Drawing No.	Order No.	Description	Quantity
1	CLK V3151	WS1 NUT 1" QUICK CONNECT	2
2	CLK V3150	WS1 SPLIT RING	2
3	CLK V3105	O-RING 215	2
4	CLK V3629LF	WS1 FTG 1" BRASS SHARKBITE LF	2

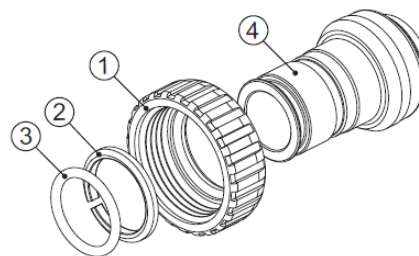

CLK V300715 WS1 FTG 3/4 JG QC 90 Assembly			
Drawing No.	Order No.	Description	Quantity
1	CLK V3151	WS1 NUT 1 QC	2
2	CLK V3150	WS1 SPLIT RING	2
3	CLK V3105	O-RING 215	2
4	CLK V3790	WS1 ELBOW 3/4 QC W/STEM	2

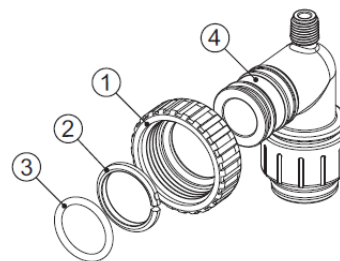

CLK V300717 WS1 FTG 1" JG QC Assembly			
Drawing No.	Order No.	Description	Quantity
1	CLK V3105	O-RING 215	2
2	CLK V3150	WS1 SPLIT RING	2
3	CLK V3151	WS1 NUT 1 QC	2
4	CLK V4045	WS1 FTG 1 INCH QC	2

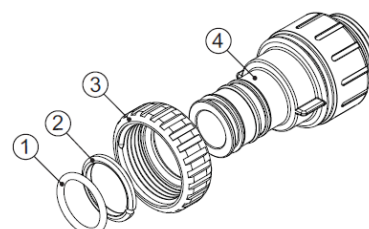

5) QUICK REFERENCE GUIDE

Manual Regeneration

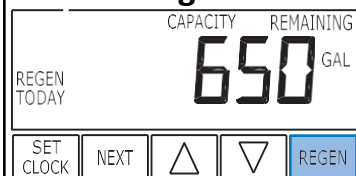

Immediate Regeneration: - Press and hold "REGEN" button for more than 3 seconds. Press "REGEN" button to advance the unit to next cycle in regeneration.

Delayed Regeneration: - Press and release "REGEN" button once the "REGEN TODAY" will be flashing on screen. Now the regeneration will occur tonight at preset time. The delayed regeneration can be cancelled by pressing "REGEN" button again.

Note: - If brine tank needs to be refilled please fill the salt at least two hours before regeneration.

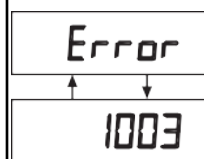

This error screen and error number will toggle. Contact Service Technician or OEM and report the error code.

NORMAL OPERATION

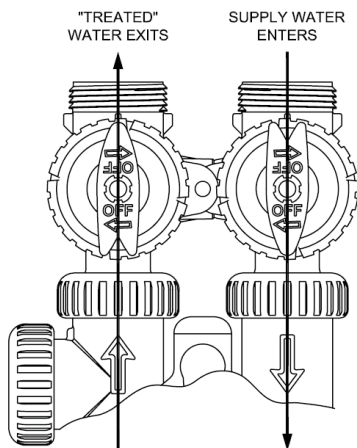

Normal Position: - The inlet and outlet valve must be fully open and bypass valve must be fully closed.

BYPASS OPERATION

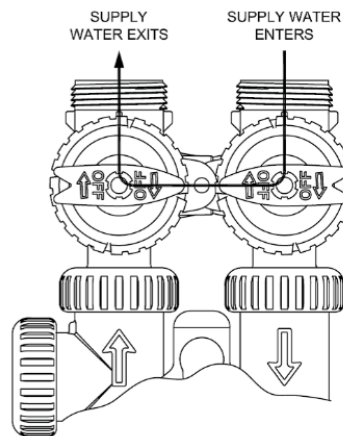

Bypass Position: - To shut off supply to the Unit the inlet and outlet valves must be fully closed and bypass valve must be fully open.

6) NO HARD WATER BYPASS (NHWB)

Drawing No.	Order No.	Description	Quantity	
			V3070FF	V3070FM
1	V3073	MAV/NOHWBY COVER ASY	1	1
2	V3476	WS MOTOR ASY 8 FT	1	1
3	V3592	SCREW #8-3/4 PHPN T-25 SS	3	3
4	V3262-01	WS1.5&2ALT/2BY REDUCGEARCVRAS	1	1
5	V3110-01	WS1 DRIVE REDUCING GEAR PLAIN	3	3
6	V3264	WS2 BYPASS REDUCTION GEAR AXLE	3	3
7	V3527	SCREW 1/4-20 X 3/4 BHSCS SS	4	4
8	V3072	MAV/NOHWBY 1/125/15 DRIVE ASY	1	1
9	V3506-01	MAV/NOHRD 1/125/15 PISTON	1	1
10	V3074	MAV 1/125/15 STACK ASY	1	1
11	V3521FF	NOHRD WTR BYPASS BODY ASY F-F	1	N/A
12	V3521FM	NOHRD WTR BYPASS BODY ASY F-M	N/A	1
13	V3151	WS1 NUT 1 QC	N/A	1
14	V3150	WS1 SPLIT RING	N/A	1
15	V3105	O-RING 215	N/A	1
*16	V3042	WS1/1.25/1.5 MAV & NHWB SERVICE PACK		

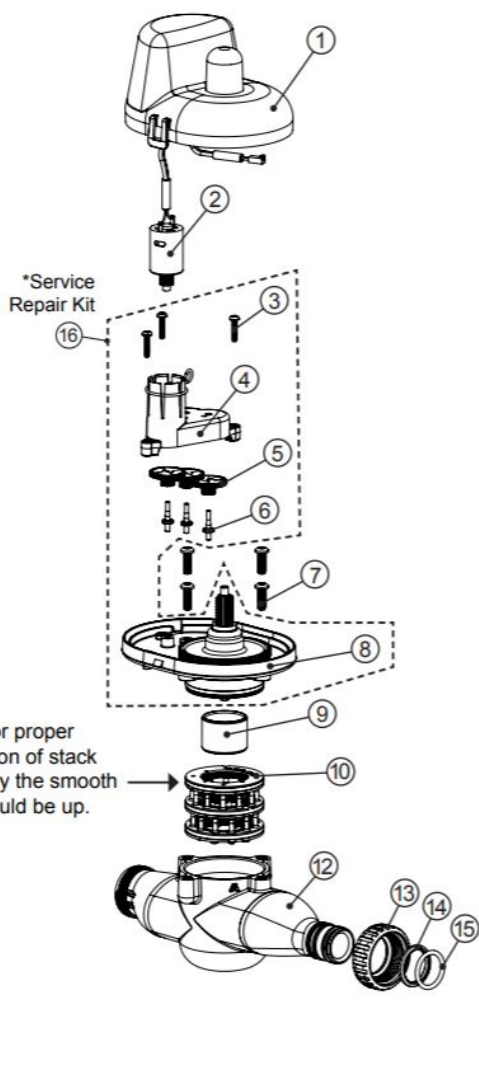

•Operating Pressures:
20 PSI Minimum / 125 PSI Maximum
•Operating Temperatures:
40°F Minimum / 110°F Maximum

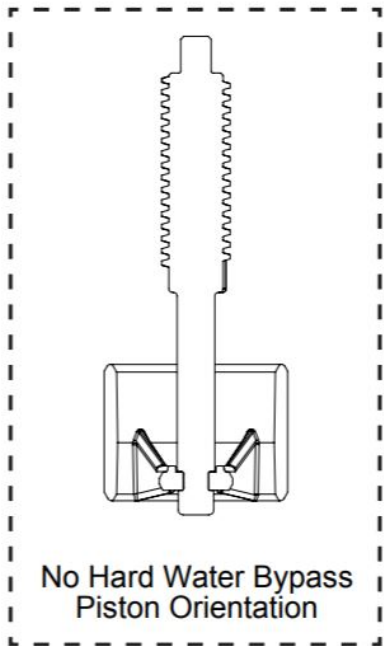

7) SERVICE INSTRUCTIONS

7.1) Front Cover Removal

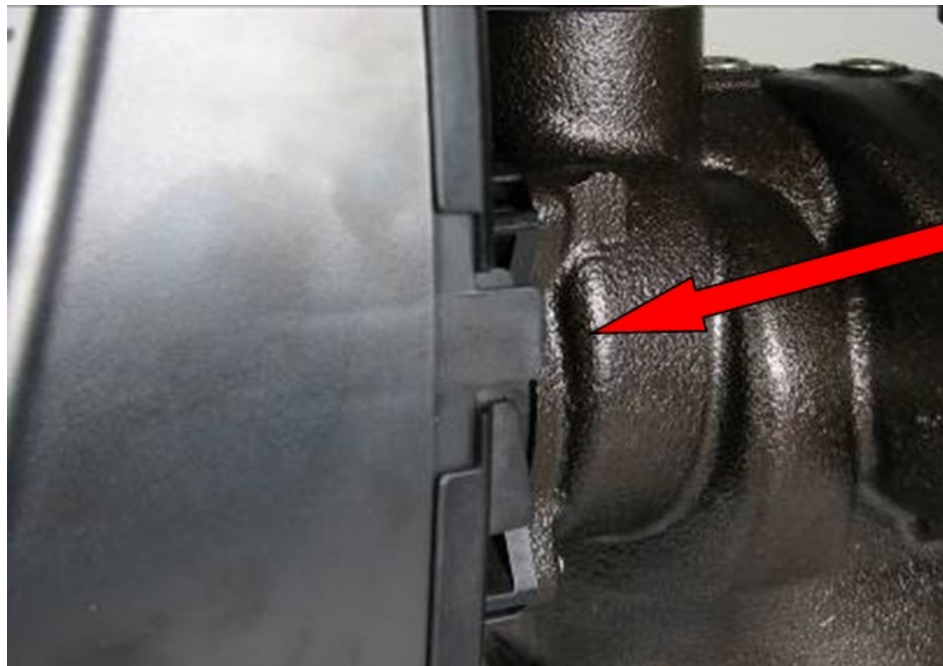

Pull out on each side of the covers locking tabs

7.2) PC Board Removal

**Lift up on PC Board locking tab
Last to remove PC Board**

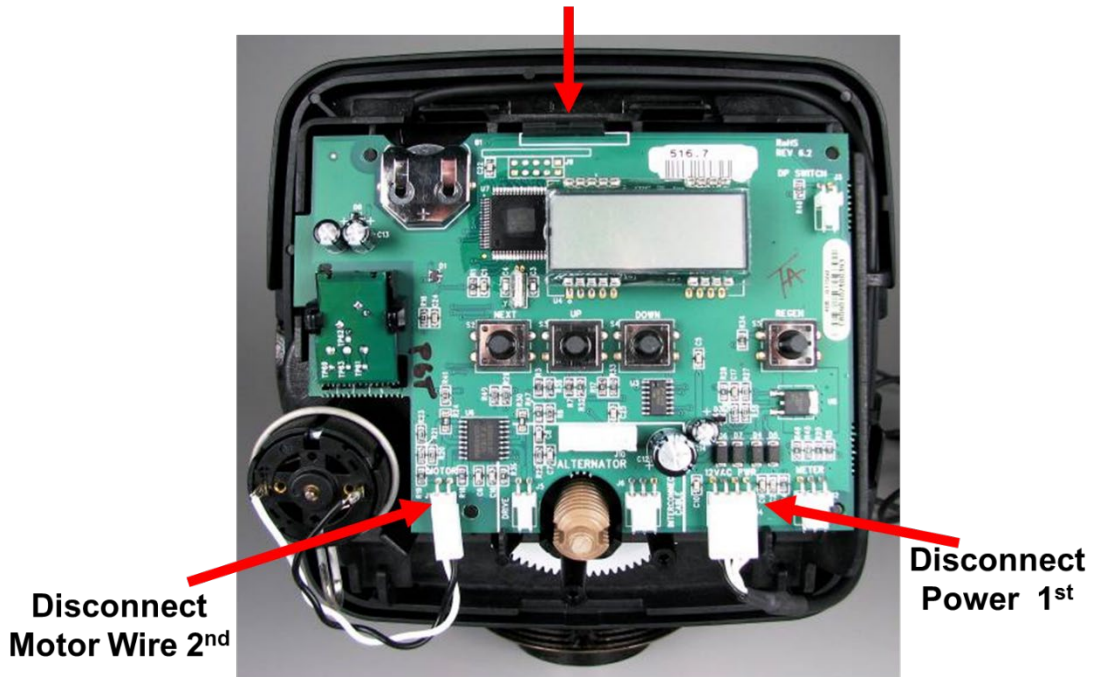

1. Lift up the locking tab and then pull out the PC board from top.
2. Disconnect the power cable first and then disconnect other cables.

**Lithium Coin Cell Battery
3 volt type 2032**

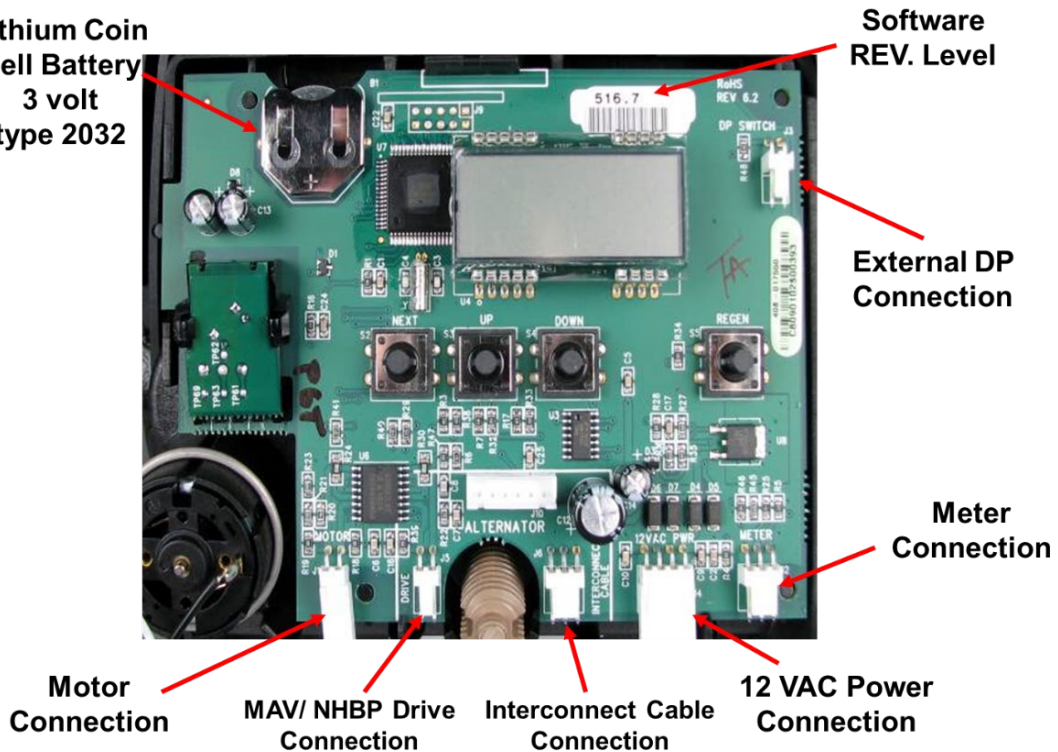

7.3) Drive Bracket Removal

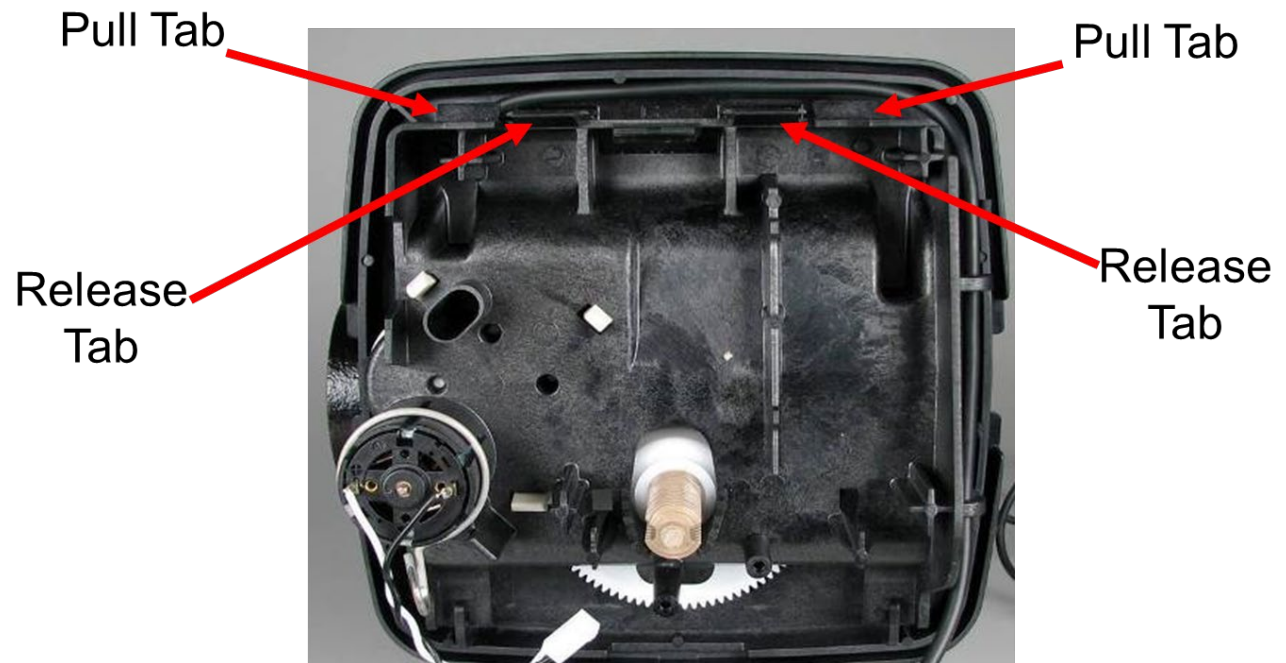

Lift up both release tabs with thumbs and use index fingers to pull out the pull tab.



Motor can be removed by pressing the locking spring to the right and then pull the motor out. Gearbox can be removed by pushing the beige colored locking tabs inwards.

7.4) Drive Cap Removal



Turn the drive cap counter clockwise with the closed end of service wrench.



Pull out the drive cap with main piston.

7.5) Piston Removal



Fully extend the piston by rotating white gear. Then put a side pressure in the direction of cavity to snap off the piston from rod.



The main piston is attached with snap off connection.

7.6) Stack Assembly Removal

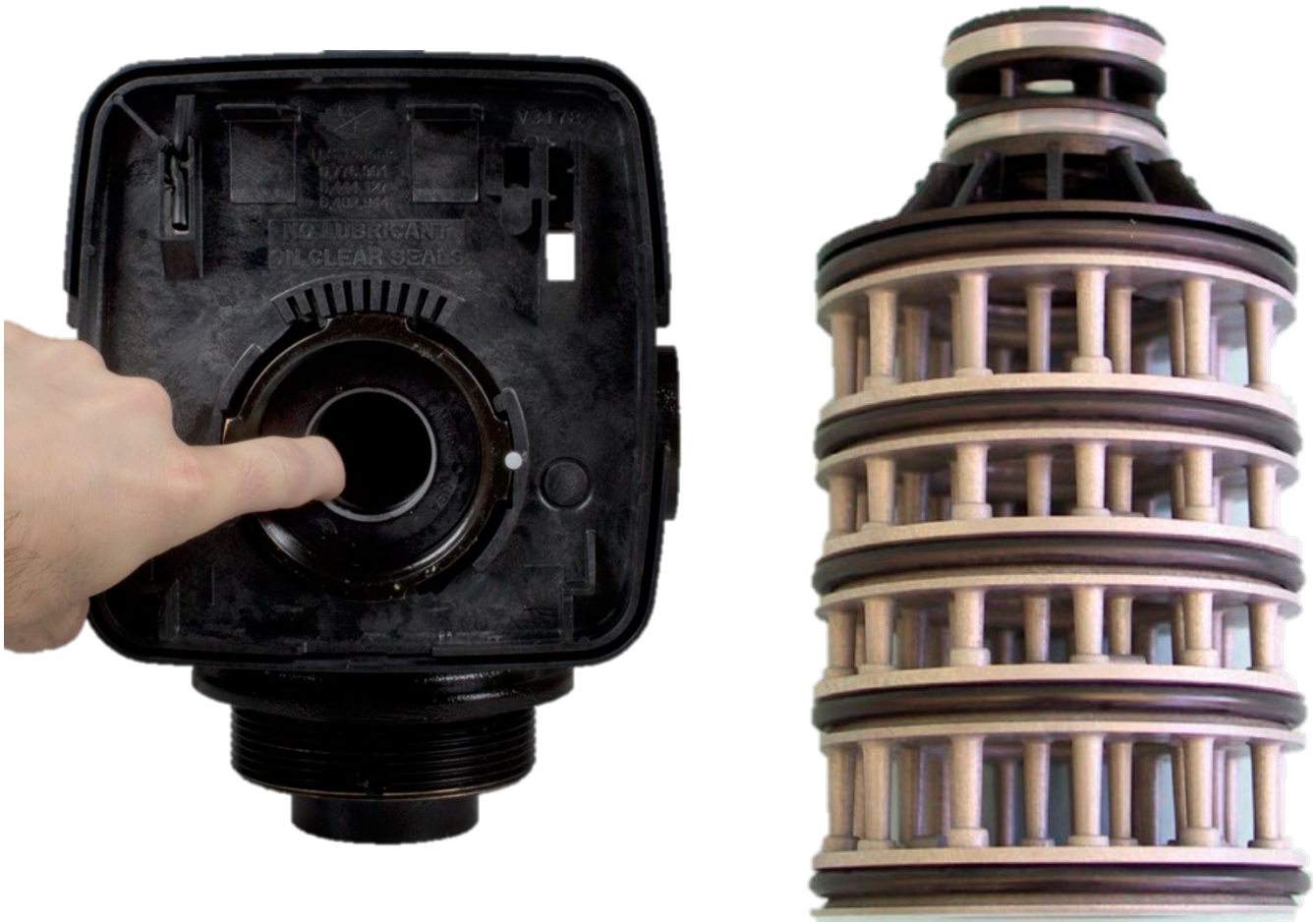

Stack assembly can be simply pulled out by hand from the control valve body.

8) TROUBLESHOOTING

8.1) Possible Error Codes

Possible Errors	
Code	Description
Err-1001	Control unable to sense motor movement
Err-101	
Err-1002	Control Valve motor ran too short
Err-102	
Err-1003	Control Valve motor ran too long and unable to find next cycle
Err-103	
Err-1004	Control Valve ran too long and timed out
Err-104	
Err-1006	MAV/NHWP motor ran too long
Err-106	
Err-1007	MAV/NHWP motor ran too short and stalled
Err-107	

8.2) Troubleshooting Procedures

Problem	Possible Cause	Solution
1. No Display on PC Board	a. No power at electric outlet	a. Repair outlet or use working outlet
	b. Control valve Power Adapter not plugged into outlet or power cord end not connected to PC board connection	b. Plug Power Adapter into outlet or connect power cord end to PC Board connection
	c. Improper power supply	c. Verify proper voltage is being delivered to PC Board
	d. Defective Power Adapter	d. Replace Power Adapter
	e. Defective PC Board	e. Replace PC Board
2. PC Board does not display correct time of day	a. Power Adapter plugged into electric outlet controlled by light switch	a. Use uninterrupted outlet
	b. Tripped breaker switch and/or tripped	b. Reset breaker switch and/ or GFI switch
	c. Power outage	c. Reset time of day. If PC Board has battery back up present the battery may be depleted. See Front Cover and Drive Assembly drawing for instructions.
	d. Defective PC Board	d. Replace PC Board
3. Display does not indicate that water is flowing. Refer to user instructions for how the display indicates water is flowing	a. Bypass valve in bypass position	a. Turn bypass handles to place bypass in service position
	b. Meter is not connected to meter connection on PC Board	b. Connect meter to three pin connection labeled METER on PC Board
	c. Restricted/ stalled meter turbine	c. Remove meter and check for rotation or foreign material
	d. Meter wire not installed securely into three pin connector	d. Verify meter cable wires are installed securely into three pin connector labeled METER
	e. Defective meter	e. Replace meter
	f. Defective PC Board	f. Replace PC Board
4. Control valve regenerates at wrong time of day	a. Power outage	a. Reset time of day. If PC Board has battery back up present the battery may be depleted. See Front Cover and Drive Assembly drawing for instructions.
	b. Time of day not set correctly	b. Reset to correct time of day
	c. Time of regeneration set incorrectly	c. Reset regeneration time
	d. Control valve set at "on 0" (immediate regeneration)	d. Check programming setting and reset to NORMAL (for a delayed regen time)
	e. Control valve set at "NORMAL + on 0" (delayed and/ or immediate)	e. Check programming setting and reset to NORMAL (for a delayed regen time)
5. Time of day flashes on and off	a. Power outage	a. Reset time of day. If PC Board has battery back up present the battery may be depleted. See Front Cover and Drive Assembly drawing for instructions.
6. Control valve does not regenerate automatically when the REGEN button is depressed and held.	a. Broken drive gear or drive cap assembly	a. Replace drive gear or drive cap assembly
	b. Broken Piston Rod	b. Replace piston rod
	c. Defective PC Board	c. Defective PC Board
7. Control valve does not regenerate automatically but does when the REGEN button is depressed and held.	a. Bypass valve in bypass position	a. Turn bypass handles to place bypass in service position
	b. Meter is not connected to meter connection on PC Board	b. Connect meter to three pin connection labeled METER on PC Board
	c. Restricted/ stalled meter turbine	c. Remove meter and check for rotation or foreign material
	d. Incorrect programming	d. Check for programming error
	e. Meter wire not installed securely into three pin connector	e. Verify meter cable wires are installed securely into three pin connector labeled METER
	f. Defective meter	f. Replace meter
	g. Defective PC Board	g. Replace PC Board

FILTER INSTALLATION AND USER GUIDE

Problem	Possible Cause	Solution
8. Unfiltered water is being delivered	a. Bypass valve is open or faulty	a. Fully close bypass valve or replace
	b. Media is exhausted due to high water usage	b. Check program settings or diagnostics for abnormal water usage
	c. Meter not registering	c. Remove meter and check for rotation or foreign material
	d. Water quality fluctuation	d. Test water and adjust program values accordingly
	e. No regenerant or low level of regenerant in regenerant tank	e. Add proper regenerant to tank
	f. Control fails to draw in regenerant	f. Refer to Trouble Shooting Guide number 12
	g. Insufficient regenerant level in regenerant tank	g. Check refill setting in programming. Check refill flow control for restrictions or debris and clean or replace
	h. Damaged seal/stack assembly	h. Replace seal/stack assembly
	i. Control valve body type and piston type mix matched	i. Verify proper control valve body type and piston type match
	j. Fouled media bed	j. Replace media bed
9. Water running to drain	a. Power outage during regeneration	a. Upon power being restored control will finish the remaining regeneration time. Reset time of day.
	b. Damaged seal/ stack assembly	b. Replace seal/ stack assembly
	c. Piston assembly failure	c. Replace piston assembly
	d. Drive cap assembly not tightened in properly	d. Re-tighten the drive cap assembly
10. E1, Err – 1001, Err – 101 = Control unable to sense motor movement	a. Motor not inserted full to engage pinion, motor wires broken or disconnected	a. Disconnect power, make sure motor is fully engaged, check for broken wires, make sure two pin connector on motor is connected to the two pin connection on the PC Board labeled MOTOR. Press NEXT and REGEN buttons for 3 seconds to resynchronize software with piston position or disconnect power supply from PC Board for 5 seconds and then reconnect.
	b. PC Board not properly snapped into drive bracket	b. Properly snap PC Board into drive bracket and then Press NEXT and REGEN buttons for 3 seconds to resynchronize software with piston position or disconnect power supply from PC Board for 5 seconds and then reconnect.
	c. Missing reduction gears	c. Replace missing gears

FILTER INSTALLATION AND USER GUIDE

Problem	Possible Cause	Solution
11. E2, Err – 1002, Err – 102 = Control valve motor ran too short and was unable to find the next cycle position and stalled	a. Foreign material is lodged in control valve	a. Open up control valve and pull out piston assembly and seal/ stack assembly for inspection. Press NEXT and REGEN buttons for 3 seconds to resynchronize software with piston position or disconnect power supply from PC Board for 5 seconds and then reconnect.
	b. Mechanical binding	b. Check piston and seal/ stack assembly, check reduction gears, check drive bracket and main drive gear interface. Press NEXT and REGEN buttons for 3 seconds to resynchronize software with piston position or disconnect power supply from PC Board for 5 seconds and then reconnect.
	c. Main drive gear too tight	c. Loosen main drive gear. Press NEXT and REGEN buttons for 3 seconds to resynchronize software with piston position or disconnect power supply from PC Board for 5 seconds and then reconnect.
	d. Improper voltage being delivered to PC Board	d. Verify that proper voltage is being supplied. Press NEXT and REGEN buttons for 3 seconds to resynchronize software with piston position or disconnect power supply from PC Board for 5 seconds and then reconnect.
12. E3, Err – 1003, Err – 103 = Control valve motor ran too long and was unable to find the next cycle position	a. Motor failure during a regeneration	a. Check motor connections then Press NEXT and REGEN buttons for 3 seconds to resynchronize software with piston position or disconnect power supply from PC Board for 5 seconds and then reconnect.
	b. Foreign matter built up on piston and stack assemblies creating friction and drag enough to time out motor	b. Replace piston and stack assemblies. Press NEXT and REGEN buttons for 3 seconds to resynchronize software with piston position or disconnect power supply from PC Board for 5 seconds and then reconnect.
	c. Drive bracket not snapped in properly and out enough that reduction gears and drive gear do not interface	c. Snap drive bracket in properly then Press NEXT and REGEN buttons for 3 seconds to resynchronize software with piston position or disconnect power supply from PC Board for 5 seconds and then reconnect.
13. Err – 1004, Err – 104 = Control valve motor ran too long and timed out trying to reach home position	a. Drive bracket not snapped in properly and out enough that reduction gears and drive gear do not interface	a. Snap drive bracket in properly then Press NEXT and REGEN buttons for 3 seconds to resynchronize software with piston position or disconnect power supply from PC Board for 5 seconds and then reconnect.

9) 5 YEAR WARRANTY

Commercial Progressive Water Filter

Thank you for your purchase of our COMMERCIAL PROGRESSIVE WATER FILTER. For proof of purchase, please retain your Invoice/Sales Order Copy.

Warranty ~ Offered

Excalibur Water Systems warrants its products to be free from defect in materials and workmanship to the original owner from the date on the proof of purchase as described below.

Warranty ~ Working Procedures

If during the suitable warranty period, a part is defective, then Excalibur Water Systems will repair or replace that part at no charge to the original owner, with the exception of charges for nominal shipping, service and/or installation.

Warranty ~ Coverage Outlined

Excalibur Water Systems guarantees, to the original owner, a period of 5 years, the CONTROL BODY to be free of defects in materials and workmanship and to perform its proper functions. To the original owner, a period of 5 years, the ELECTRONIC CONTROL VALVES as well as all parts to be free of defects in materials and workmanship and to perform their normal functions. To the original owner the MINERAL TANKS will not rust, corrode, leak, burst or in any other form fail to perform their proper functions for a period of 10 YEARS.

Warranty ~ Service

In the event you require service, Excalibur Water Systems Dealer will provide all necessary service and installation for your Commercial Water Filter. To obtain warranty service within 30 days of discovery of the defect, notification must be given to Excalibur Water Systems.

General Provisions

The above warranties are effective provided the WATER FILTER is operated at water pressures not exceeding 125psi and at water temperatures not exceeding 120°F; also provided that the water filter is not subject to abuse, misuse, alteration, neglect, freezing, accident or negligence; and provided further that the water filter is not damaged as the result of any unusual force of nature such as, but not limited to flood, hurricane, tornado or earthquake. Excalibur Water Systems is excused if failure to perform its warranty obligations is the result of strikes, government regulation, materials shortages or other circumstances beyond its control.

THERE ARE NO WARRANTIES ON THE WATER FILTER BEYOND THOSE SPECIFICALLY DESCRIBED ABOVE. ALL IMPLIED WARRANTIES, INCLUDING ANY IMPLIED WARRANTY OF MERCHANTABILITY OR OF FITNESS FOR A PARTICULAR PURPOSE, ARE DISCLAIMED TO THE EXTENT THEY MIGHT EXTEND BEYOND THE ABOVE PERIODS. THE SOLE OBLIGATION OF EXCALIBUR WATER SYSTEMS UNDER THESE WARRANTIES IS TO REPLACE OR REPAIR THE COMPONENT OR PART PROVES TO BE DEFECTIVE WITHIN THE SPECIFIED TIME PERIOD AND EXCALIBUR WATER SYSTEMS IS NOT LIABLE FOR CONSEQUENTIAL OR INCIDENTAL DAMAGES. NO DEALER, AGENT, REPRESENTATIVE OR OTHER PERSON IS AUTHORIZED TO EXTEND OR EXPAND THE WARRANTIES EXPRESSED ABOVE.

Certain provinces or states do not allow limitations on how long an implied warranty lasts or exclusions or limitations of incidental or consequential damage, therefore limitations and exclusions in this warranty may not apply to you. This warranty extends you specific legal rights as you may have other rights which vary from province to province or state to state.

Excalibur Water Systems is a manufacturer of water treatment products.

142 Commerce Park Drive

Barrie, Ontario Canada

