



Quality through innovation

1.5" PROGRESSIVE CHEMICAL REMOVAL INSTALLATION AND USER GUIDE

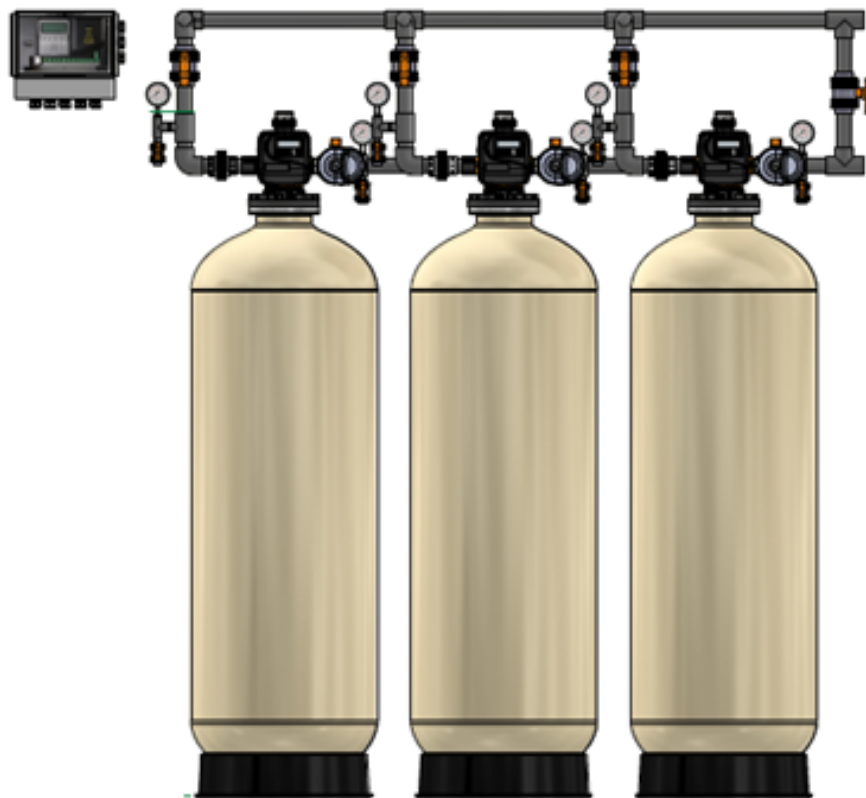

TABLE OF CONTENTS

- 1) Installation 3
 - 1.1) Pre-installation instructions..... 3
 - 1.2) General Installation and Service Warnings..... 3
 - 1.3) Site Requirements..... 3
 - 1.4) Installation Drawing..... 4
 - 1.5) System Drawing 5
 - 1.6) Plumbing 5
 - 1.7) Drain Line 6
 - 1.8) 3-Way Bypass Valve 6
 - 1.9) Loading Instructions..... 8
 - 1.10) Start Up Instructions 9
- 2) Control Valve Programming..... 10
 - 2.1) Regeneration and Error Screens 10
 - 2.2) Button Operation 10
 - 2.3) User Displays..... 11
 - 2.4) Setting Time of Day 12
 - 2.5) Configuration Settings 12
 - 2.6) Installer Display Settings..... 13
 - 2.1) Filter System Setup 14
 - 2.2) Diagnostics 15
 - 2.3) Programming 17
- 3) System Controller Programming..... 19
 - 3.1) General Button Operation and Other Displays..... 19
 - 3.1) User Displays..... 20
 - 3.2) Set Time of Day and Day of Week..... 21
 - 3.3) System Setup Displays 22
 - 3.4) Configuration Displays 24
 - 3.5) Diagnostic Displays..... 25
 - 3.6) History Displays..... 26
 - 3.7) Data Extraction..... 27
 - 3.8) Flash Programming of System Controller 27
 - 3.9) Network Webpage Setup Procedure 27

- 3.10) Network Configuration Displays 28
- 3.11) System Controller Programming Summary 29
- 4) Control Valve..... 30
 - 4.1) Specifications 30
 - 4.2) Components of Control Valve 32
- 5) NO HARD WATER BYPASS (NHWB) 36
- 6) Service Instructions..... 37
 - 6.1) Front Cover Removal 37
 - 6.2) PC Board Removal..... 38
 - 6.3) Drive Bracket Removal..... 39
 - 6.4) Drive Cap Removal..... 40
 - 6.5) Piston Removal 41
 - 6.6) Stack Assembly Removal..... 42
 - 6.7) Injector Cap Removal 43
- 7) Troubleshooting..... 44
 - 7.1) Possible Error Codes 44
 - 7.2) Troubleshooting Procedures..... 45
- 8) 5 Year Warranty..... 49

1) INSTALLATION

1.1) Pre-installation instructions

The cycle times, sequence of cycles, media dose refill time and exchange capacity are preset to default by OEM. The installer must change the values according to the water test results, day override and time of regeneration. Set time of day, read normal operating displays, read power loss and error displays.

WATER TEST

Iron	_____	ppm
pH	_____	number
*Nitrates	_____	ppm
Manganese	_____	ppm
Sulphur	_____	yes/no
Total Dissolved Solids	_____	ppm

1.2) General Installation and Service Warnings

- The filter is designed so that it can be installed easily with minor plumbing changes on previous plumbing.
- The piping must be clamped properly and the weight of the plumbing must not be on the filter.
- Do not use any kind of lubricant including silicone. A silicone based lubricant can be only used on O-Rings but not necessary.
- The nuts and caps can be fastened and unfastened by hand or the plastic service wrench. Do not use pipe wrench to tighten the caps and nuts.

1.3) Site Requirements

- Water Pressure: - 40-110 psi
- Water Temperature: - 40-110°F (4.4-43°C)
- Electrical- 115/120 V, 60Hz Uninterrupted Outlet
- Current required is 0.5 Amperes
- The plug-in transformer is for dry locations only
- The tank should be on a firm level surface

1.4) Installation Drawing

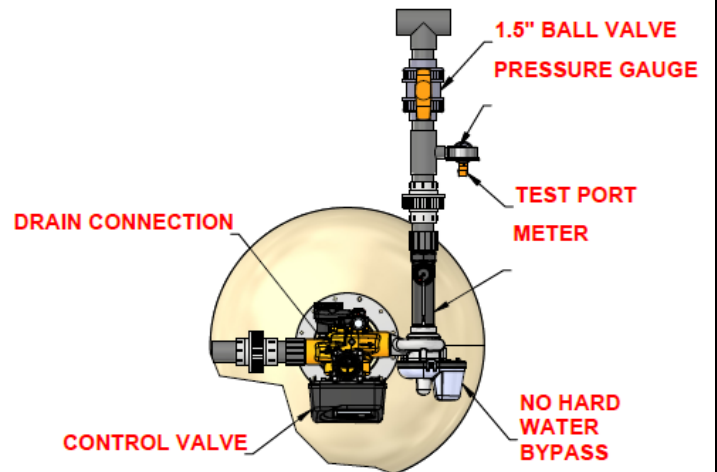
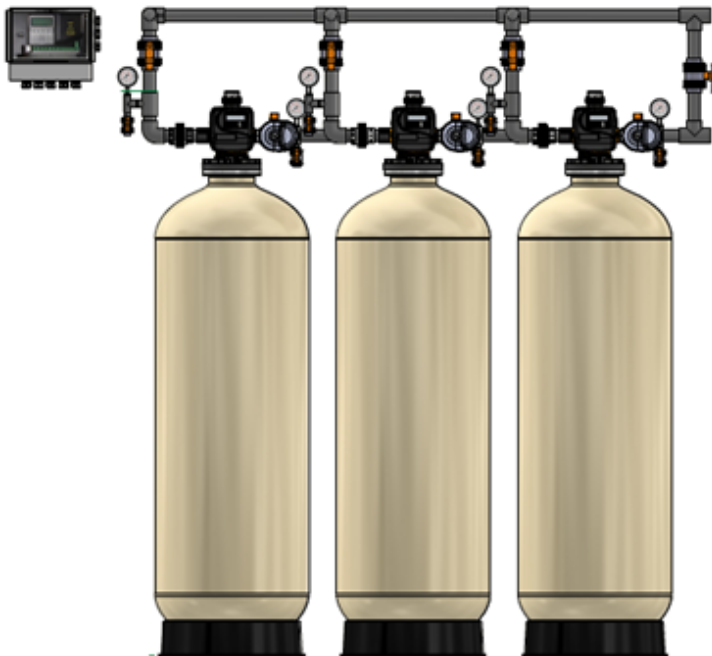
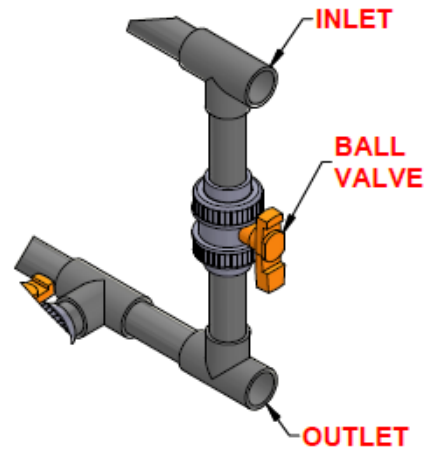
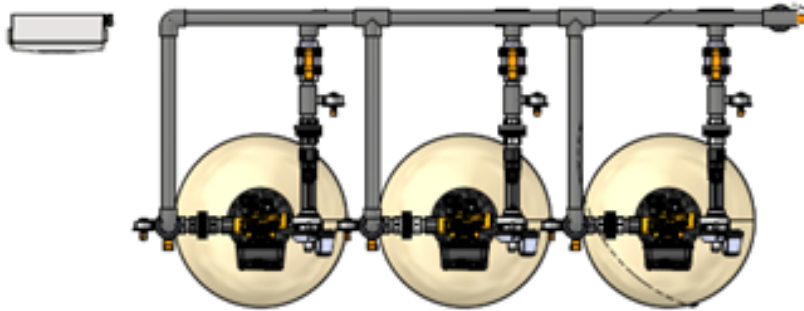

1.5) System Drawing

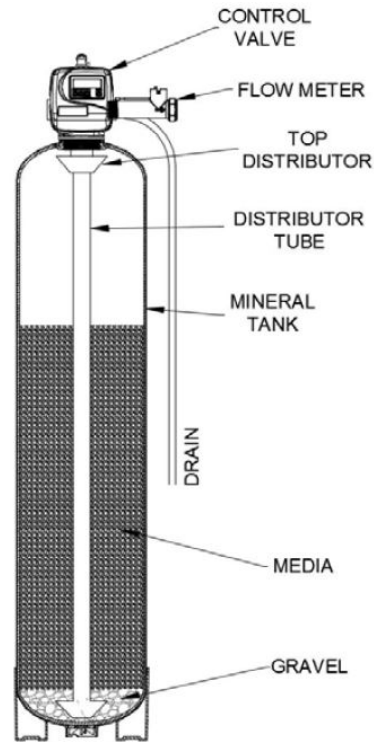

1.6) Plumbing

- The system must be close to drain as much as possible.
- The unit including the drain must be located in a room temperature above 33° F.
- The 3-way bypass valves must be installed on the control valves.
- The primer, solder or solder flux must not get on the O-rings.
- After soldering the lines must be cooled before installing the O-Rings, nuts and caps.
- If the electrical system is grounded to the plumbing than copper strap must be connected between inlet and outlet as shown in figure above.
- The plumbing must be done by following the local plumbing codes.
- Never let the vacuum occur in tank this may cause implosion and leakage. If vacuum occurrence is expected than vacuum breaker must be installed in inlet line.

1.7) Drain Line

- The size of the drain must be according to the specifications.
- Leave minimum of 6" gap between flow control fitting and solder joints. The gap less than this can damage the flow control.
- Use ¾", 1" or 1.25" tubing for drain line according to the specifications.
- If the drain line is elevated and then emptied into the drain below the level the of control valve the 7" loop should make at the end of drain line.
- The air gap between the drain and the end of the drain line must be twice the diameter of the tube.
- The strap must be tied at the end to secure the line.

1.8) 3-Way Bypass Valve

The shut off valves must be installed at inlet and outlet of the progressive flow filter. The bypass pipe including the ball valve must also be installed to bypass the hard water to demand outlet.

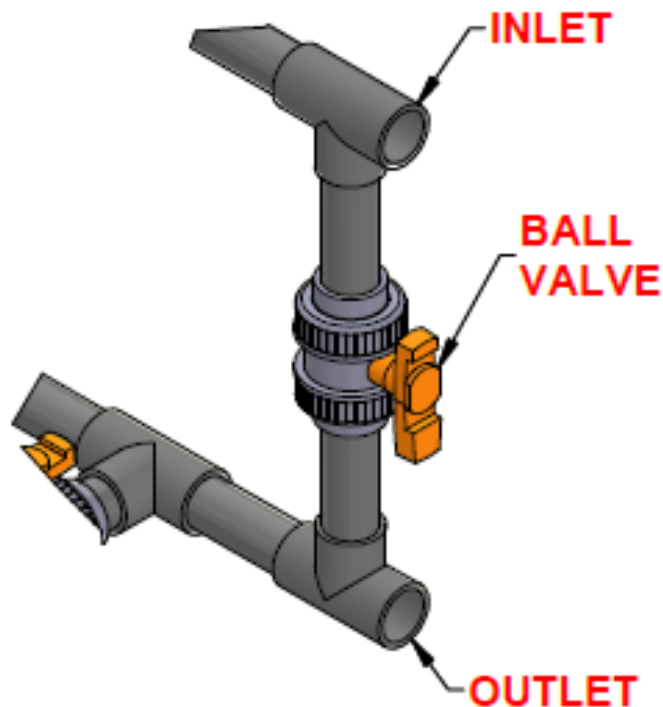

FILTER INSTALLATION AND USER GUIDE

NORMAL POSITION

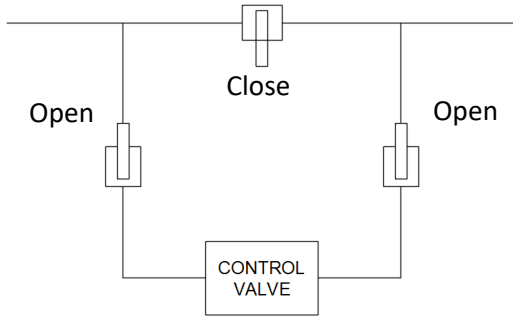

Normal Position: - Fully close the bypass valve and fully open both valves at inlet and outlet of the control valve. The supply water (untreated) enters in and treated water exits.

BYPASS POSITION

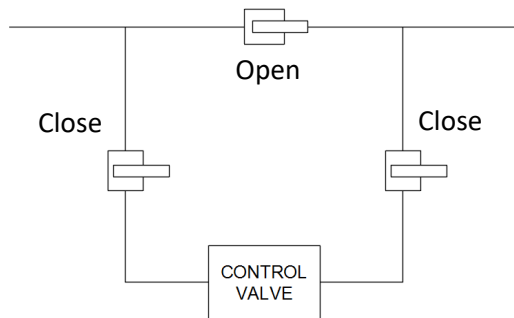

Bypass Position: - The inlet and outlet valves at the control valve must be fully closed but the bypass valve must be fully open. The supply water enters and bypass the control valve and exits untreated as supply water.

DIAGNOSTIC POSITION

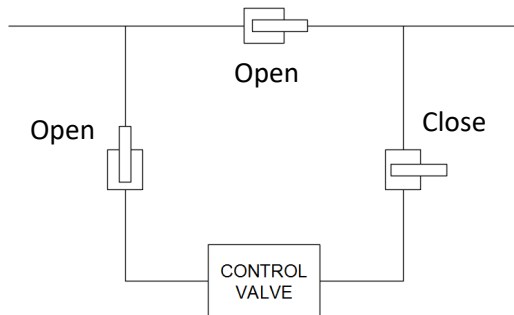

Diagnostic Position: - The outlet valve must be fully closed but bypass valve and inlet valve must be fully open. The untreated water will be supplied.

SHUT OFF POSITION

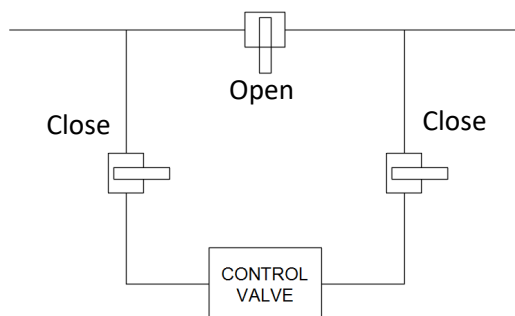

Shut Off Position: - All three valves must be at fully closed position. The water supply is shut down means there will be no flow at the outlet.

1.9) Loading Instructions

Step 1: Check the product upon removal and remove from box packaging checking for any shipping damage or shortages that must be reported to Excalibur Water Systems immediately for confirmation.

Step 2: Insert distributor(s) inside of media mineral tank(s) so it is positioned properly in the bottom centre groove. If not already sized properly cut the top of the distributor pipe $\frac{1}{2}$ - $\frac{3}{4}$ " above top of tank opening and clean off and excess PVC materials with grit cloth.

Step 3: Plug the top inlet opening of the distributor (Hub & Lateral) or bottom stack with a clean cloth, rag, or tape to prevent any gravel or media from entering into the distributor tube.

Step 4: Load the gravel under bedding onto the mineral tank using a funnel or some sort of loading device. If multiple layers of gravel with different sizes being utilized always load the largest gravel size in diameter to the smallest last.

Step 5: Load the filtration media also using a funnel or some sort of loading device until all media is inside of mineral tank.

Step 6: Remove top opening cover of the distributor carefully not to move or disturb the distributor tube not allowing any debris or materials to get inside of the now loaded filter(s).

Step 7: Thread on control valves onto top opening tanks be sure to check and verify that the O-ring on the bottom base of the control valve is present and properly lubricated with silicone. Tighten control valve(s) clockwise until you have reached the end of the thread and have secured a watertight seal. (If control valves that utilize quick connect collars thread the collars the same into the tanks then attach control valves).

Step 8: Precede now with the unit(s) in their proper installation locations to run piping and materials for all inlet, outlet, and drain connections properly with isolation valves and test ports for future water tests. Also unions should be included in installation materials for easy future servicing of the control valves when necessary on all inlet, outlet, and drain lines.

1.10) Start Up Instructions

- Keep the 3-way bypass valves in bypass position by keeping inlet and outlet valves fully closed and bypass valve fully open. Now the untreated water is being supplied. Open the faucet downstream of filter system until water comes clear out of it. The initial water can be dirty because of installation debris. Now inspect the leaks in plumbing.
- Press and hold the “REGEN” button down for 5 seconds to start manual regeneration. The drive motor will start the backwash cycle and countdown time begins. Turn the inlet bypass valve handles halfway into the direction of service operation. Once the steady water flows out of drain then fully open the bypass valve into the direction of service operation.
- Press REGEN button to advance the regeneration to rinse cycle. The water will come through the drain. Allow this process until water coming through the drain becomes clear.

2) CONTROL VALVE PROGRAMMING

2.1) Regeneration and Error Screens



Regen Screen

Displays the time remaining in the current cycle. Pressing REGEN advances to the next cycle.

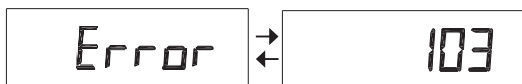

Error Screen

Alternated flashing Error and error code every 3 seconds.

Clear by disconnecting the power supply at the PC board and reconnecting, or press NEXT and REGEN simultaneously for 3 seconds.

2.2) Button Operation



Scrolls to the next display.



- Pressing once and releasing will schedule a regeneration at the preset delayed regeneration time.
- Pressing again and releasing will cancel the regeneration.
- Pressing and holding for 3 seconds will initiate an immediate regeneration
- Pressing while in regeneration will advance to the next cycle.
- Pressing in the program levels will go backwards to the previous screen



Change Variable being displayed.



Key sequence to lock and unlock program settings



Holding for 3 seconds initiates a control reset. The software version is displayed and the piston returns to the home/service position, resynchronizing the valve.

2.3) User Displays

When the system is operating, one of five displays may be shown. Pressing NEXT will alternate between the displays shown below.

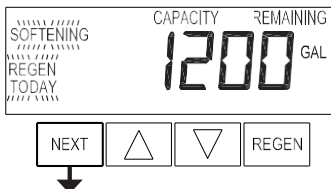

User 1

Typical user display. Shows volume remaining to regeneration. This screen will not be viewed if the control is set for time-clock operation.

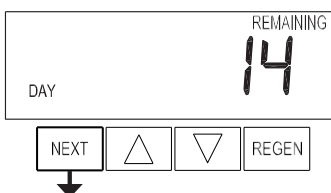

User 2

Displays number of days to next regeneration.

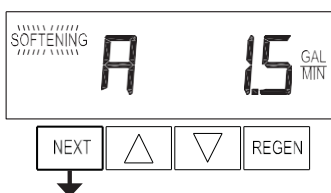

User 3

Flow Rate.
Displays present flow rate.

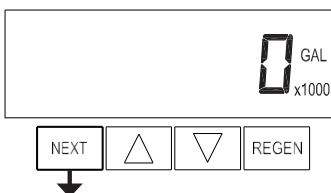

User 4

Displays total volume in gallons since last reset. If a meter is not used this display will be shown but 0 will be displayed.
PRESS ▼ FOR 3 SECONDS TO RESET TO 0.

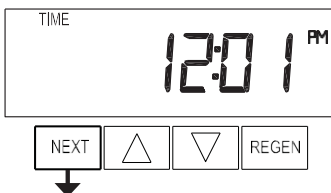

User 5

Shows current time.

2.4) Setting Time of Day

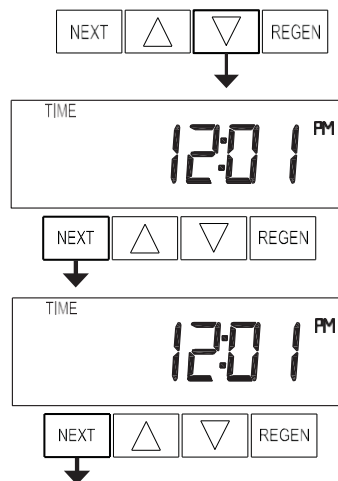

- Push NEXT button until time of day screen is displayed.
- Press and hold ▼ until SET TIME is displayed and the hour flashes once.
- Press ▲ or ▼ until the correct hour is displayed. Then press NEXT.
- The minutes will flash. Press ▲ or ▼ until the correct minute is displayed. Press NEXT to return to the User Displays.

If a power outage lasts less than 8 hours and the time of day flashes on and off, the battery should be replaced and the time should be reset.

2.5) Configuration Settings

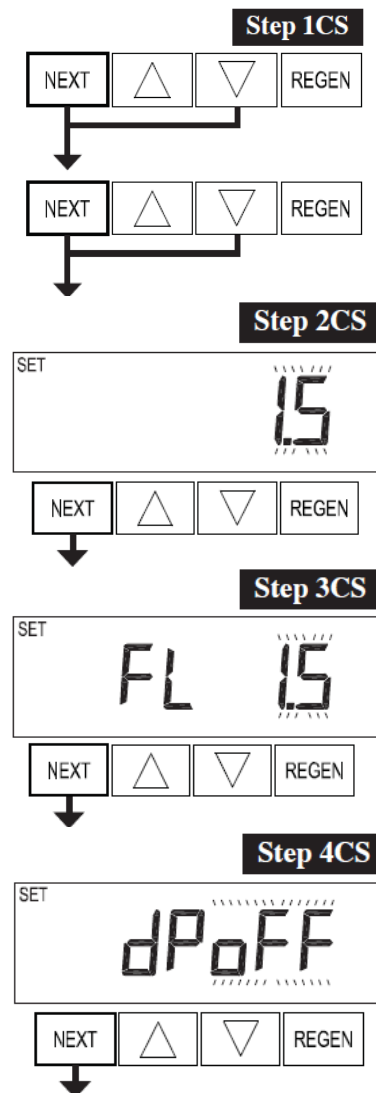

Step 1CS – Press NEXT and ▼ simultaneously for 5 seconds and release. Press NEXT and ▼ simultaneously for 5 seconds and release. If the screen in Step 2CS does not appear, the lock on the valve is activated. To unlock, press ▼, NEXT, ▲ and REGEN in sequence, then press NEXT and ▼ simultaneously for 5 seconds and release. Press NEXT and ▼ simultaneously for 5 seconds and release.

Step 2CS – Use ▲ or ▼ to select 1.5 for 1.5" valve. Press NEXT to go to Step 3CS. Press REGEN to exit Configuration Settings.

Step 3CS – Use ▲ or ▼ to select "1.5" meter size. Press NEXT to go to Step 4CS. Press REGEN to return to previous step.

Step 4CS – Select dP off – outside regeneration signal feature not used, by using ▲ or ▼ buttons.

Press NEXT to go to Step 4CS. Press REGEN to return to previous step.

Step 5CS

RETURN TO NORMAL SCREENS

Step 5CS – Select “SYS” when control valve is connected to system controller using ▲ or ▼ buttons. Then press NEXT button to go to Step 5CS. Press REGEN to return to previous step.

2.6) Installer Display Settings

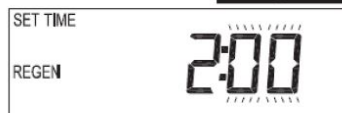
Step 1I**Step 2I****Step 3I****Step 4I**

Exit Installer Display Settings

Step 1I - To enter Installer Display press NEXT and ▲ simultaneously for about 5 seconds and release.

Step 2I – Day Override: Set “4” maximum number of days between regenerations using ▲ or ▼ :
Press NEXT to go to step 4I. Press REGEN to return to previous step.

Step 3I – Next Regeneration Time (hour): Set the hour of day for regeneration using ▲ or ▼ . The default time is 2:00.
Press NEXT to go to step 5I. Press REGEN to return to previous step.

Step 4I – Next Regeneration Time (minutes): Set the minutes of day for regeneration using ▲ or ▼ .
Press NEXT to exit Installer Display Settings. Press REGEN to return to previous step.

2.1) Filter System Setup

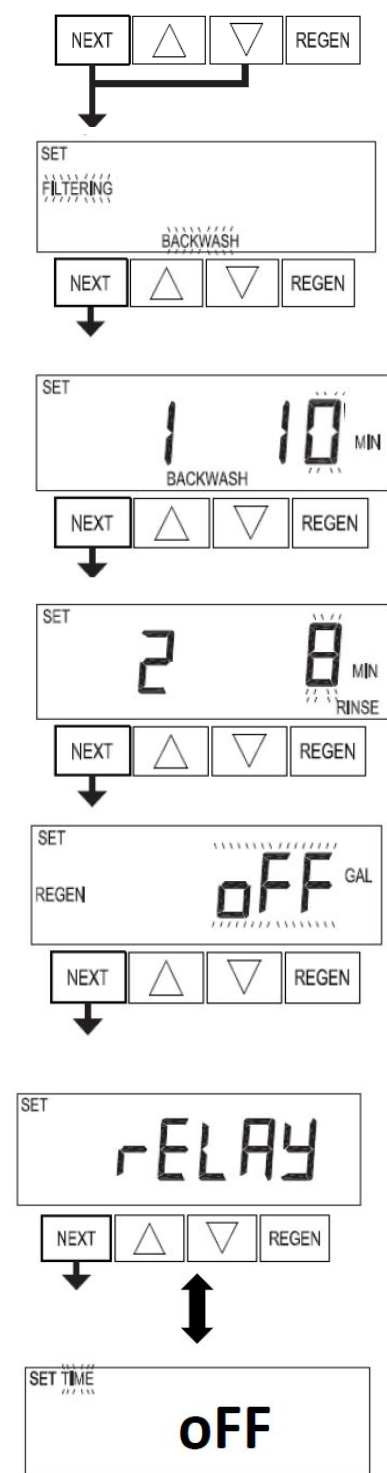

Step 1F - Press NEXT and ▼ simultaneously for 5 seconds and release.

Step 2F – Choose “FILTERING BACKWASH” using ▲ or ▼. Press NEXT to go to Step 3S. Press REGEN to exit OEM Filter System Setup.

Step 3F – Select the 10-minute time for the first/backwash cycle using ▲ or ▼. Press NEXT to go to Step 4F. Press REGEN to return to previous step.

Step 4F – Select the 8-minute time for second/fast rinse cycle using ▲ or ▼. Press NEXT to go to step 5F.

Step 5F – Set the regeneration trigger using ▲ or ▼ to adjust the number of gallons as per specifications of filter model.

Step 6S – Select relay operation “oFF” using ▲ or ▼ buttons. Press NEXT to exit filter system setup.

2.2) Diagnostics

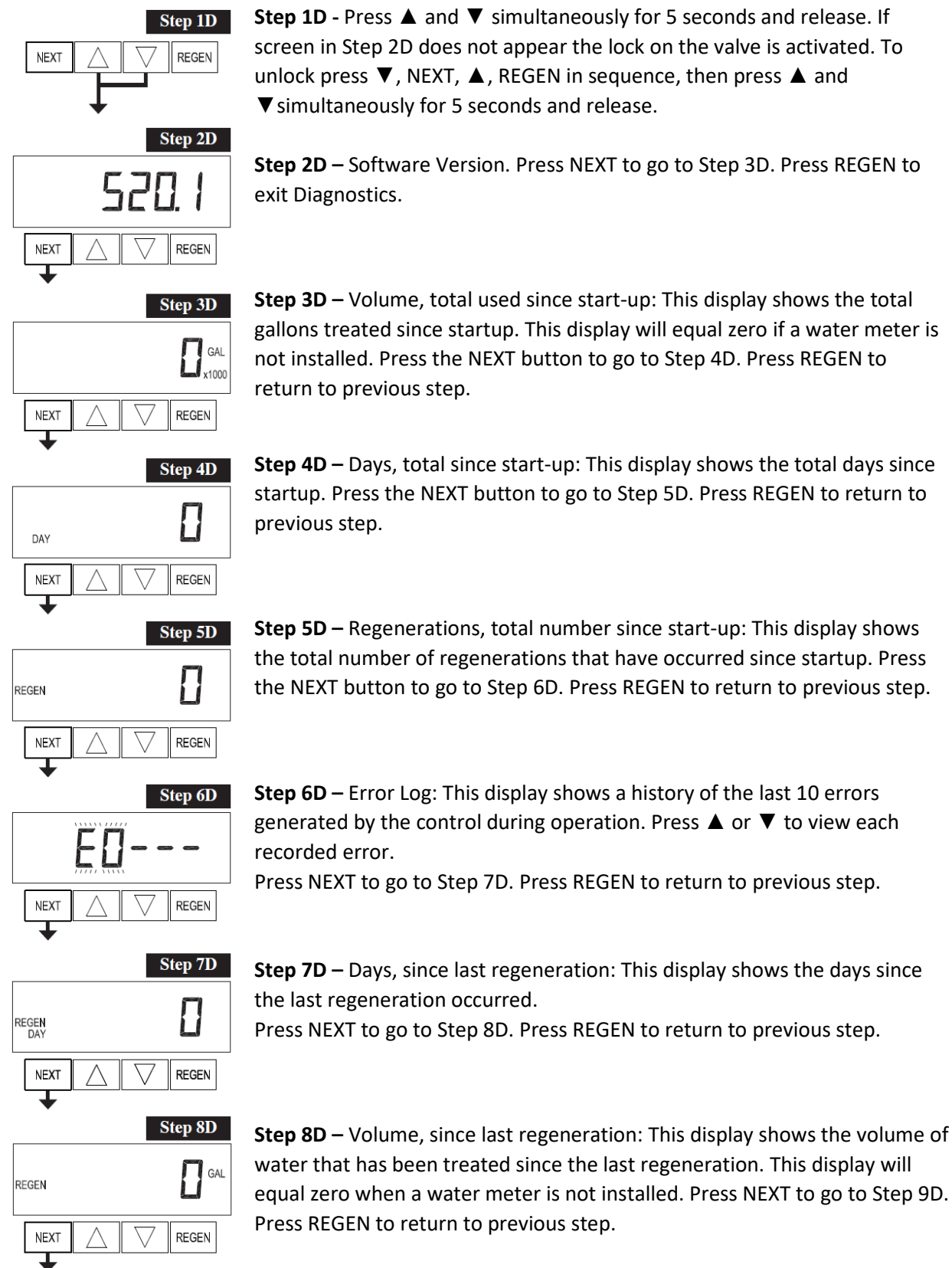

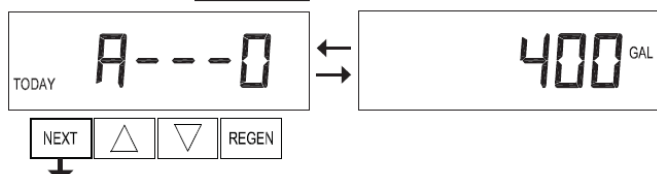
Step 9D

Step 9D – Volume, reserve capacity used for last 7 days. This display shows day 0 (for today) and flashes the reserve capacity. Pressing ▲ will show day 1 (which would be yesterday) and flashes the reserve capacity used. Pressing ▲ again will show day 2 (the day before yesterday) and the reserve capacity. Keep pressing ▲ to show the capacity for days 3, 4, 5 and 6. ▼ can be pressed to move backwards in the day series.

Press NEXT at any time to go to Step 10D. Press REGEN to return to previous step.

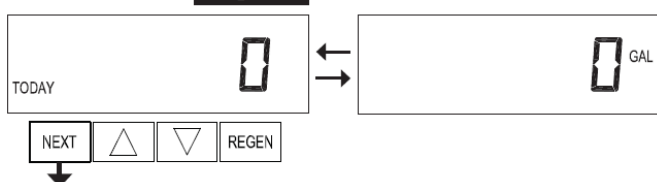
Step 10D

Step 10D – Volume, 63-day usage history: This display shows day 0 (for today) and flashes the volume of water treated today. Pressing ▲ will show day 1 (which would be yesterday) and flashes the volume of water treated on that day. Continue to press ▲ to show the maximum volume of water treated for the last 63 days. If a regeneration occurred on that day, the word “REGEN” will also be displayed. This display will show dashes if a water meter is not installed.

Press NEXT at any time to go to Step 11D. Press REGEN to return to previous step.

FILTER INSTALLATION AND USER GUIDE

Model Variable Programming and Components

2.3) Programming

Model # ↓	Mineral Tank	3F	4F
Step →		Backwash Mins	Fast Rinse
EWS FSC15NCS4	16x65	10	8
EWS FSC15NCS5	18x65		
EWS FSC15NCS6	21x62		
EWS FSC15NCS8	24x72		
EWS FSC15NCS12	30x72		

Configuration Settings				
Step #	2CS	3CS	4CS	5CS
Option	1.5	1.5	oFF	SYS

OEM Filter System Setup					
Step #	2F	3F	4F	5F	6F
Option	Filtering Backwash	10	8	Off	Off

Model	Drain Flow Control		
	FLOW	drain line size	order#
EWS FSC15NCS4	13	1.5	V3190-130 (x1)
EWS FSC15NCS5	17		V3190-170 (x1)
EWS FSC15NCS6	25		V3190-250 (x1)
EWS FSC15NCS8	31.5		V3190-250 (x1) V3162-065 (x1)
EWS FSC15NCS12	47.5		V3190-250 (x1) V3162-075 (x3)

Model	Vessel Media (ft ³)	Flow Rates (GPM – per vessel)				
		Minimum	Chloramine Removal	TOC Removal	Chlorine Removal	Backwash
EWS FSC15NCS4	4	1.6	3.0	4.0	12.0	13
EWS FSC15NCS5	5	2.0	3.8	5.0	15.0	17
EWS FSC15NCS6	6	2.4	4.5	6.0	18.0	25
EWS FSC15NCS8	8	3.2	6.0	8.0	24.0	31.5
EWS FSC15NCS12	12	4.8	9.0	12.0	36.0	47.5

3) SYSTEM CONTROLLER PROGRAMMING

3.1) General Button Operation and Other Displays



Set clock from any user screen. Exit & save from setup or program screens.



Move to the next display



Used in initiating a manual regeneration. Moves back one display while in program mode.



OR



Change variable being displayed

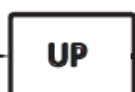

Key sequence to lock and unlock software

System Controller LED Functions

Blue LED (ONLINE): - Indicates which unit is the current “Lead” unit in the system. If the blue LED is flashing, then that Lead unit has lost communication with the system controller. The Blue LED will also transfer to the unit that has the least capacity remaining with RANDOM and SERIES system types.

Green LED (ONLINE): - Indicates which unit that is currently On-line in the system. If the green LED is flashing, then that unit has lost communication with the System Controller.

Orange LED (STANDBY): - Indicates which unit that is currently in Stand-by in the system. If the Orange LED is flashing, then that unit is detecting flow rate through this meter.

Red LED (REGEN): - Indicates which unit is currently in regeneration in the system. If the Red LED is flashing, then that unit is in error.

Green & Orange LED's: - Indicates that a unit is transferring between On-line and Stand-by.

Orange & Red (flashing) LED's: - Indicates that a unit is in error and the MAV / NHWBP valve is closed.

Green & Red (flashing) LED's: - Indicates that a unit is in error and the MAV / NHWBP valve is open.



After a flash reprogramming, select the US format to show 12 hour AM/PM timekeeping and Gallons for volume units.

FILTER INSTALLATION AND USER GUIDE



OR



Press and hold Regen button. Use "UP" and "DOWN" button to select "LEAD" or "ALL". Lead will regenerate the lead unit but all will regenerate all the unit in sequence. Press Next.



OR



Use "UP" and "DOWN" button to select "NOW" or "DELAYED". "Now" will regenerate immediately but delayed regenerated will occur at scheduled regeneration.

3.1) User Displays

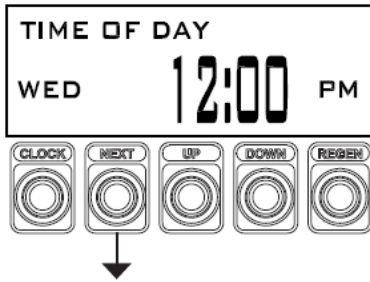

Displays Time of the day

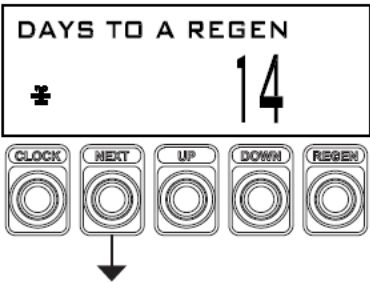

Displays the number of days between regeneration (* on the left signal the water flow)

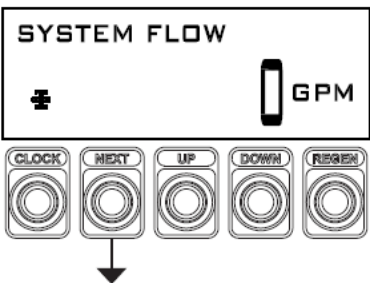

Displays the total system current flow rate

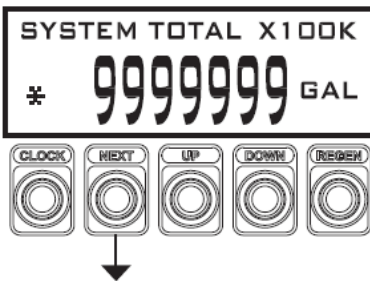

Displays the total flow in gallons since start up

3.2) Set Time of Day and Day of Week

STEP 1U

STEP 1U: - Press CLOCK.



STEP 2U

STEP 2U: - Current Time (hour): Set the hour using UP or DOWN buttons. Press NEXT to go to Step 3U. With metric units set, AM/PM indication will not appear and timekeeping will be shown in the 24-hour format.



STEP 3U

STEP 3U: - Current Time (minutes): - Set the minutes using the UP or DOWN buttons. Press NEXT to go to Step 4U.

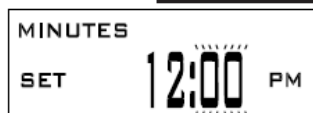

STEP 4U

STEP 4U: - Current day of the year: Set the year using the UP or DOWN buttons. Press NEXT to step 5U.



STEP 5U

STEP 5U: - Current Month: - Set the month using the UP or DOWN buttons. Press NEXT to step 6U.



STEP 6U

STEP 6U: - Current day of the month: - Set the day using the UP or DOWN buttons. Press NEXT to exit.



3.3) System Setup Displays

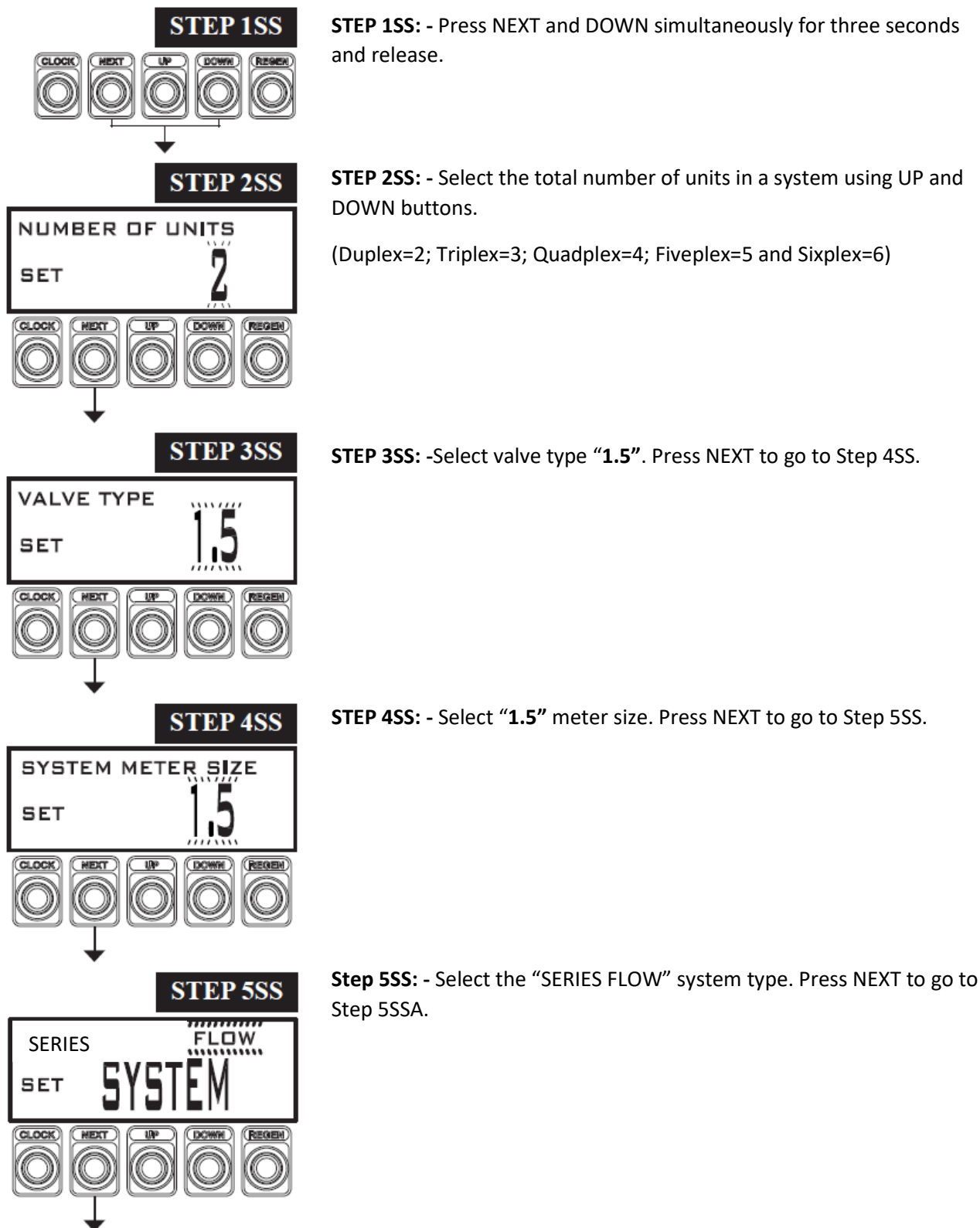

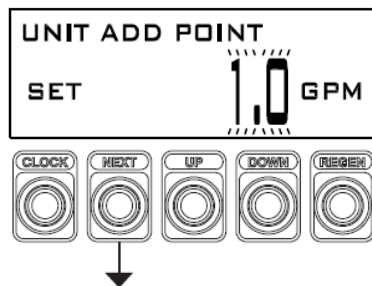
STEP 5SSA

Step 5SSA: - Adjust the unit add point in GPM as specified on the specifications of the system model. Press NEXT to go to Step 6SS.

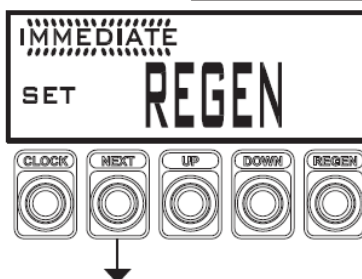
STEP 6SS

Step 6SS: - Set the regeneration to start "IMMEDIATE" when the capacity falls below reserve.

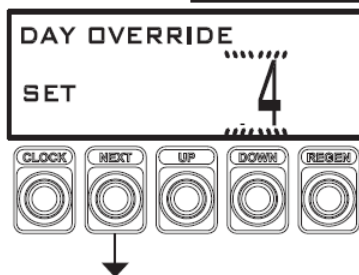
STEP 7SS

Step 7SS: - Set the maximum number of days to be "4" between regenerations.

RETURN TO NORMAL MODE

3.4) Configuration Displays

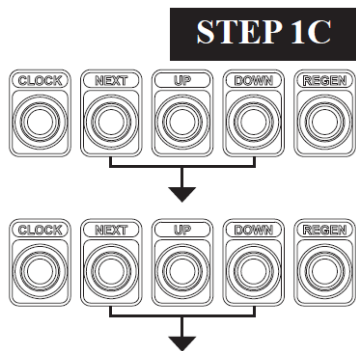

STEP 1C

STEP 1C: - Press NEXT and DOWN simultaneously for approximately three seconds, then release. Press NEXT and DOWN again simultaneously for 3 seconds and release.

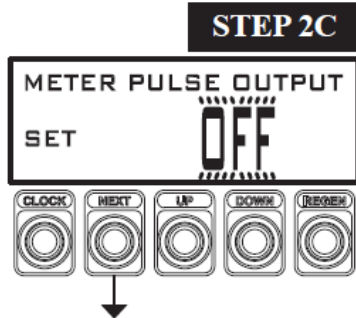

STEP 2C

STEP 2C: - Set "OFF" Meter Pulse Output operation using UP or DOWN.

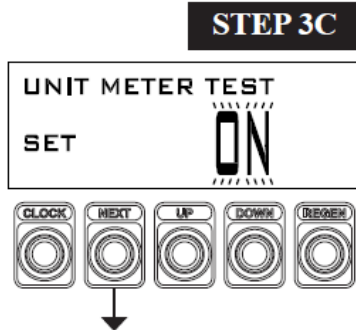

STEP 3C

STEP 3C: - Set Unit Meter Test "ON" using UP or DOWN. Press NEXT to go to Step 4C.

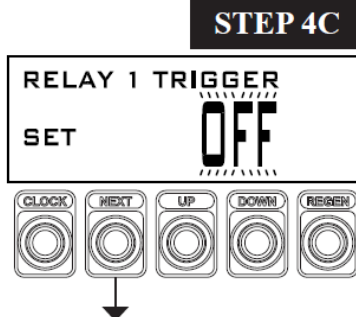

STEP 4C

STEP 4C: - Set Relay 1 trigger "OFF" using UP or DOWN buttons. Press NEXT to go to Step 5C.

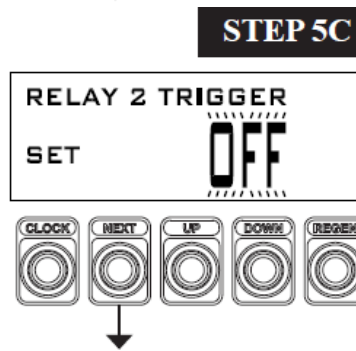

STEP 5C

STEP 5C: - Set Relay 2 Trigger "OFF" using UP or DOWN. Press NEXT to exit configuration displays.
Press NEXT to save and exit to normal mode.

3.5) Diagnostic Displays

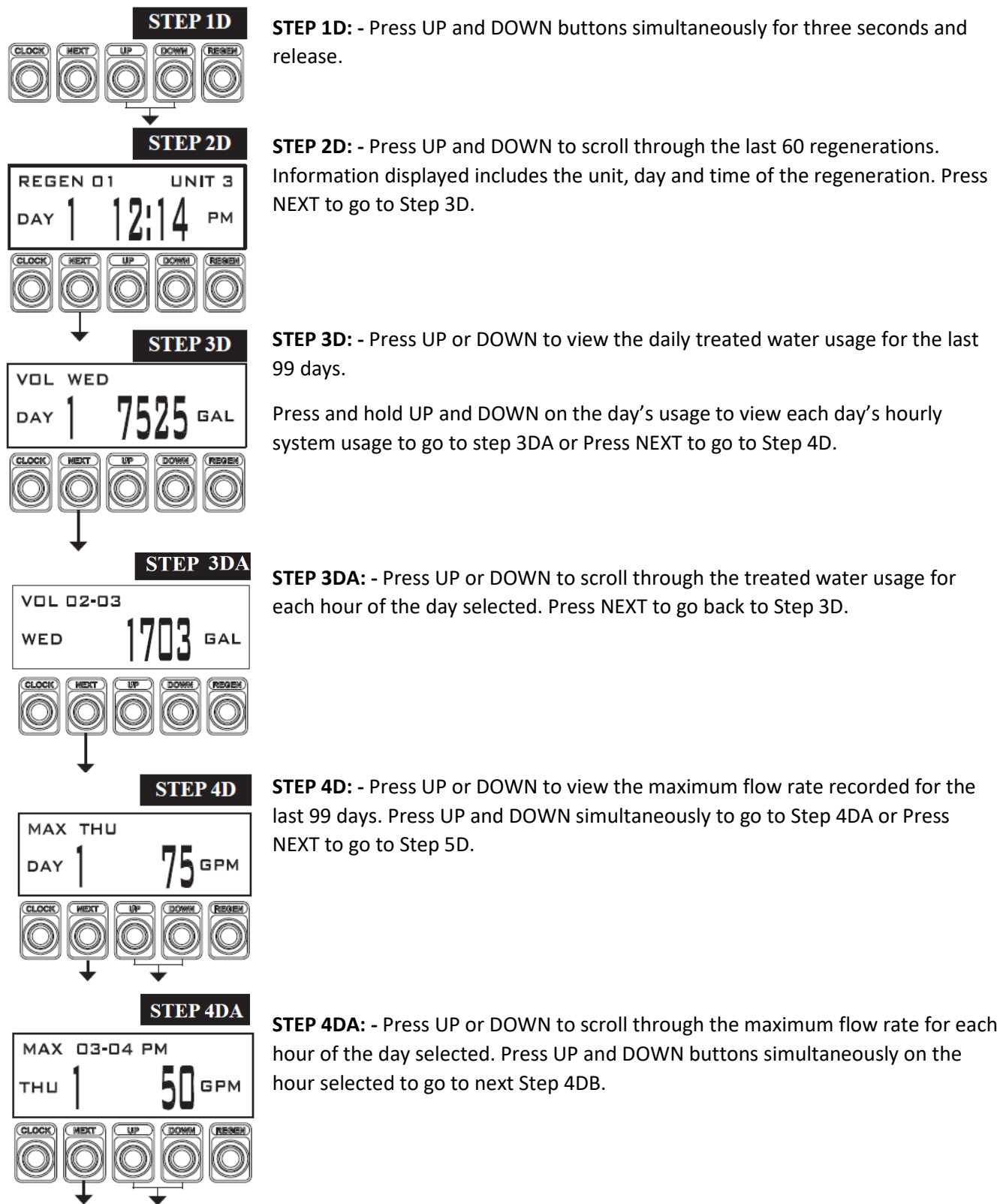

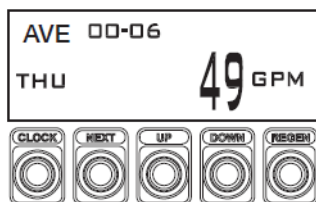
STEP 4DB

STEP 4DB: - Press UP or DOWN to scroll through the average system flow rate for the selected hour, in 6-minute interval. Press NEXT to return to Step 4DA.

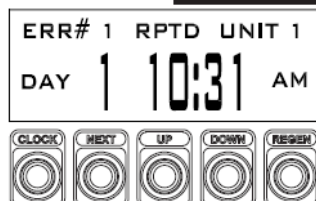
STEP 5D

STEP 5D: - This display shows the error log with last 20 valve errors and communication losses are stored in it. Use UP and DOWN buttons to scroll through the log.

DAY XX = Indicates the number of days ago

COM- = Communication lost error

RPTD = Indicates the valve error was not reset

CLRD = Indicates the valve error was finally reset

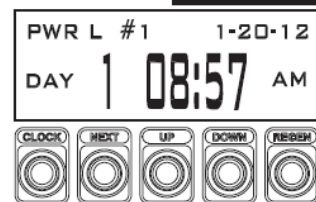
STEP 6D

STEP 6D: - Press UP or DOWN to view the last 20 power events. Press NEXT to exit Diagnostics. Press REGEN to return to previous step.

3.6) History Displays

STEP 1HD

STEP 1HD: - Press UP and DOWN simultaneously for three seconds and release. Again press UP and DOWN buttons simultaneously for three seconds and release.

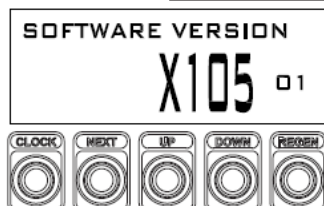
**STEP 2HD**

STEP 2HD: - Displays software rev level. Press NEXT to go to Step 3HD.

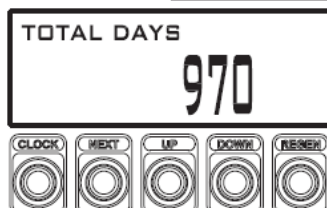
STEP 3HD

STEP 3HD: - Displays total days since startup. Press NEXT to exit to normal model.

3.7) Data Extraction

Step 1: - Ensure the USB memory device is formatted for FAT32 file system and that the allocation unit size is set for 4096 bytes.

Step 2: - Ensure that the System Controller is powered on.

Step 3: - Plug the USB memory device into the System Controller USB port.

Step 4: - During the extraction process, a series of status displays will appear. When the “USB COMPLETE” message appears, remove the USB device from the System Controller. This could take several minutes.



Step 5: - The extracted data can then be imported into the Clack Data Extraction spreadsheet.

3.8) Flash Programming of System Controller

Step 1: - Ensure the USB memory device is formatted for the FAT32 file system. If not, consult the manufacturer of the USB memory device for the latest in formatting instructions.

Step 2: - Ensure that System Controller is switched off.

Step 3: - Plug the USB memory device into the System Controller USB port.

Step 4: - Apply power to the System Controller.

Step 5: - The LCD backlight will appear blue which means working. The LCD will show no characters and all LED's will remain off for the duration of programming. When the LCD turns green, the process is complete and successful.

Step 6: - Remove the power from the System Controller.

Step 7: - Remove the USB memory device from the System Controller.

Step 8: - Reapply power to the System Controller. Normal functionality should be present.

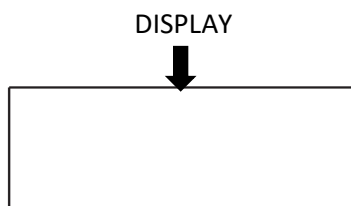

Flash Reprogramming Status Display

Blue Display = Control is being reprogrammed

Green Display = Control has been reprogrammed

Red Display = An error occurred during control reprogramming, and the reprogramming process has failed

3.9) Network Webpage Setup Procedure

Step 1: - Open the WEB.zip file.

Step 2: - Copy the “Web” folder to a USB memory device.

Step 3: - Ensure that the System Controller is powered on.

Step 4: - Plug the USB memory device into the System Controller USB port.

Step 5: - During the network web page setup process, a series of status displays will appear. When the “USB COMPLETE” message appears, remove the USB device from the System Controller.

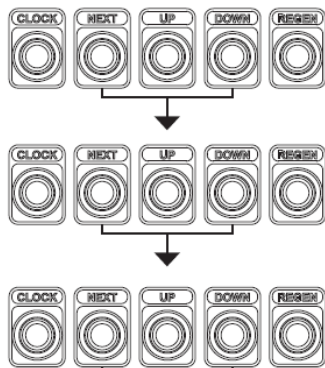

3.10) Network Configuration Displays

STEP 1NS

STEP 1NS: - Press NEXT and DOWN buttons simultaneously and release after 3 seconds. Repeat this step for another two times.

STEP 2NS

STEP 2NS: - Set the desired Host Name to identify this controller on the network. Pressing CLOCK will select the first letter, use UP or DOWN to change each letter. Press NEXT to forward to the next character. Press NEXT to go to Step 3NS. Press REGEN to go to previous character or step.

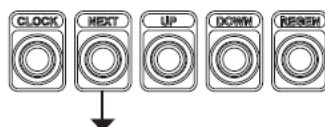
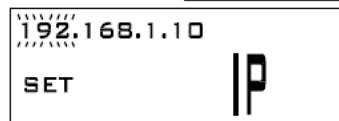
**STEP 3NS**

STEP 3NS: - IP Addressing – Set the proper static IP address. Each IP address has four sections separated by decimal points. Pressing CLOCK will select the first section of the address to be changed. Press UP or DOWN to adjust each section, using NEXT to advance to the next section and to Step 4NS.

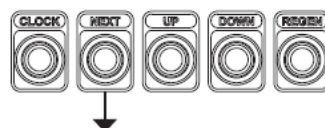
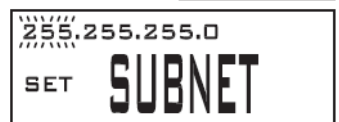
**STEP 4NS**

STEP 4NS: - Subnet Masking – Set the proper Subnet Mask. Each Subnet Mask has four sections separated by decimal points. The System Controller will only be able to communicate with other devices within the same subnet. Pressing CLOCK will select the first section of the address to be changed by pressing UP or DOWN buttons to adjust each section. Pressing NEXT will advance to the next section and to the Step 5NS.

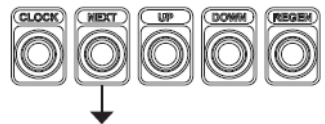
**STEP 5NS**

STEP 5NS: - MAC address – The controller's unique ID code that is set at the factory. This information is read-only for information purposes. Press NEXT to exit Network Configuration. Press REGEN to return to the previous step.

3.11) System Controller Programming Summary

System Setup		
Step #	Value	Description
2SS	2,3,4,5 or 6	Number of Units in System
3SS	1.5	1.5" Control Valves
4SS	1.5	1.5" Meter Size
5SS	SERIES	All units online only one can regenerate at a time
6SS	IMMEDIATE REGEN	Regen starts immediately without delay
7SS	4	Maximum number of days between regeneration

Configuration Settings		
Step #	Value	Description
2C	OFF	Meter Output
3C	ON	Meter Logic Test
4C	OFF	Relay 1 will always be off
5C	OFF	Relay 2 will always be off

Network Configuration Settings		
Step #	Value	Description
2NS	SYSTEM CONTROLLER	Name of System Controller on network
3NS	XXX.XXX.X.XX	Set Proper Static IP address
4NS	XXX.XXX.XXX.X	Set Proper Subnet Masking
5NS	04.81.AE.00.00.00	Unique MAC Address

4) CONTROL VALVE

4.1) Specifications



Certified to NSF/ANSI 44, 61 and 372.

- 1.5" top mount control valve suited for mid-size commercial/Industrial applications
- Epoxy coated lead free brass valve body*
- Economical stainless steel optional meter assembly
- Service flow rate of 70 gpm, backwash 52 gpm
- Solid state microprocessor with easy access front panel settings
- Front panel display for time of day, days until next regeneration, volume remaining, current flow rate and total volume used (Totalizer)
- Four methods to initiate regeneration; meter immediate, meter delayed, time clock delayed or pressure differential
- Optional double backwash feature offers optimum regeneration, cleaning ability and efficiency
- Fully adjustable cycle times with 6-cycle control delivers controlled backwash, downflow brining or upflow brining, slow rinse, second backwash, fast rinse, refill and downflow service
- Coin Cell Lithium battery back-up with a 8 hour carry over
- 12-volt output AC Adapter provides safe and easy installation
- Post treated water regenerant refill
- Patented one piece expanding seal spacer stack assembly U.S. Patent 6,402,944
- Patented linearly reciprocating piston operation U.S. Patent 6,444,127
- Reliable and proven DC drive



Optional 1.5" Meter

Specifications: -

Minimum/Maximum Operating Pressures	20 psi (138 kPa) -125 psi (862 kPa)
Minimum/Maximum Operating Temperatures	40°F (4°C) - 110°F (43°C)
Power Adapter: Supply Voltage Supply Frequency Output Voltage Output Current	110V AC 60Hz 12V AC 0.5 Amperes
No user serviceable parts are on the PC board, the motor, or the Power adapter. The means of disconnection from the main power supply is by unplugging the Power adapter	
Service flow rate	70 gpm (265 lpm, 15.9 m ³ /h) @ 15 psig (103 kPa) drop
Backwash flow rate	52 gpm (192 lpm, 11.8 m ³ /h) @ 25 psig (172 kPa) drop
CV Service	1.5" Valve: 18.1
CV Backwash	1.5" Valve: 10.4
Meter: Accuracy Flow Range	± 5% 0.5 – 75 gpm (1.9 – 283 lpm)
Inlet / Outlet	1.5" Female NPT or BSPT
Drain Line	1.25" Female NPT
Distributor Tube Opening	Female NPT Inlet & Outlet 1.90" OD (1.5" NPS)
Tank Connection	4"-8UN
Shipping Weight (with meter)	23 lbs. (11 kg)
PC Board Memory	Nonvolatile EEPROM (electrically erasable programmable read only memory)
Compatible with the following typical concentrations of regenerants/chemicals	Sodium chloride, potassium chloride, potassium permanganate, sodium bisulfite, chlorine and chloramines

4.2) Components of Control Valve

4.2.1) Front Cover and PC Board

Drawing No.	Order No.	Description	Quantity
1	V3175EE-01	WS1EE FRONT COVER ASSEMBLY	1
2	V3107-01	WS1 MOTOR	1
3	V3106-01	WS1 DRIVE BRACKET & SPRING CLIP	1
4	V3408EE-04BOARD	WS1THRU/2 EE PCB 5 DIGIT REPL	1
5	V3110	WS1 DRIVE GEAR 12X36	3
6	V3109	WS1 DRIVE GEAR COVER	1
Not Shown	V3186	WS1 AC ADAPTER 120V-12V	1
	V3186-01	WS1 AC ADAPTER CORD ONLY	
Not Shown	V3178	WS1 Drive Back Plate	1

AC Adapter	U.S.
Supply Voltage	120 V AC
Supply Frequency	60 Hz
Output Voltage	12 V AC
Output Current	500 mA

Wiring for Correct On/Off Operation	
PC Board Relay Terminal Block	Relay
RLY 1	Coil -
+ COM	Coil +

When replacing the battery, align positives and push down to fully seat.

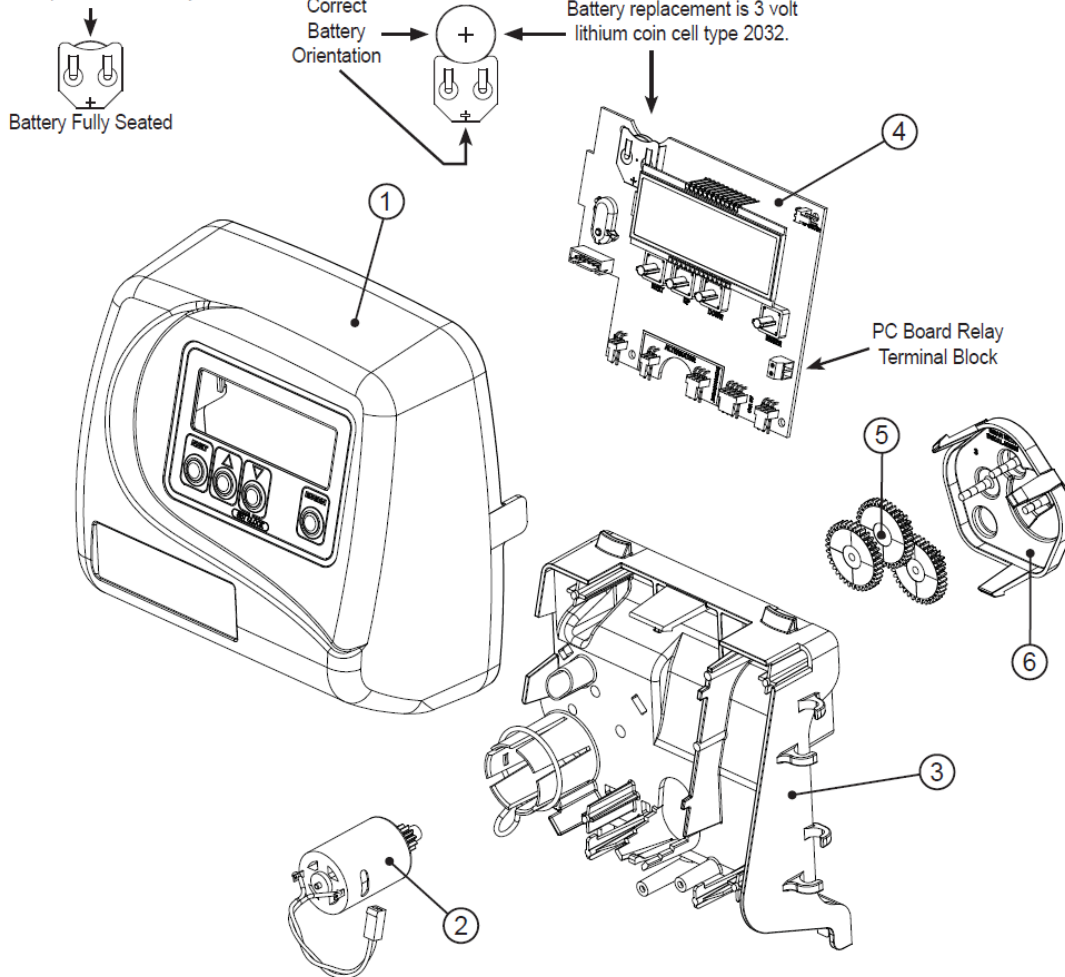

4.2.2) Drive assembly, Piston and Spacer stack

Drawing No.	Order No.	Description	Quantity
1	V3004	WS1.5 DRIVE CAP ASSEMBLY	1
2	V3135	O-RING 228	1
3	V3407	WS1.25/1.5 PISTON DOWNFLOW ASSEMBLY (AMBER IN COLOR)	1
4	V3423	WS1.5 BACKPLATE DOWEL	1
5	V3430	WS1.5 SPACER STACK ASSEMBLY	1
6	BACK PLATE	REFER TO PROGRAMMING AND COVER DRAWING MANUAL	1
7	V3419	O-RING 347	1
8	V3641	O-RING 225 FOR VALVE BODIES WITH NPT THREADS	1
9	V3950-01	WS 1.5 NPT VALVE BODY, W/V3468	1
NOT SHOWN	V3468	TEST PORT PLUG, 1/4" NPT	2
10	D1300	TOP BAFFLE DIFFUSER, 1.5/50MM	1

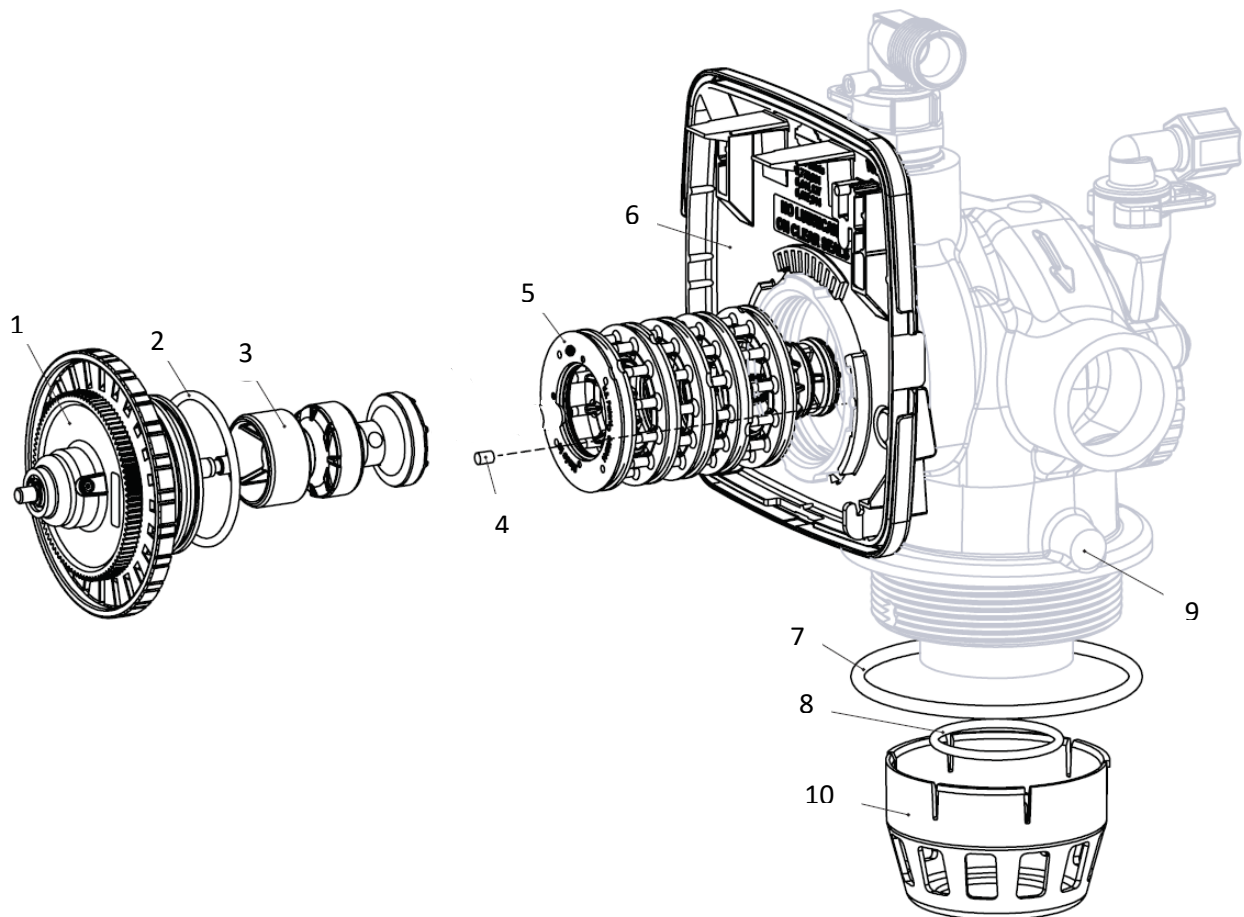

4.2.3) Drain Line Flow Control

Item	Part#	Description	Qty.
V3158-04		WS Drain Fitting, 3/4" Elbow	
1	V3158-03	Drain Elbow, 3/4 NPT	1
2	V3159-01	DLFC Retainer Assembly	1
3	V3163	O-ring, -019	1
4	H4615	Locking Clip	1
5*	V3983	WS2 DLFC Adapter	1
6	V3162-xx	See DLFC Section	1

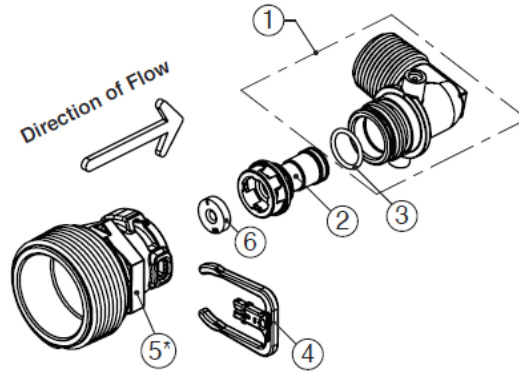

Item	Part#	Description	Qty.
V3008-05		WS Drain Fitting, 1" Straight	
1	V3167	WS Drain Fitting Adapter, 1" NPT	1
2	V3166-01	Drain Fitting Body	1
3	V3151	WS1 Nut, QC	1
4	V3150	WS1 Split Ring	1
5	V3105	O-ring -215	1
6	V3163	O-ring -019	1
7	H4615	Locking Clip	1
8**	V3983	WS2 DLFC Adapter	1
9	V3190-xx	See DLFC Section	1

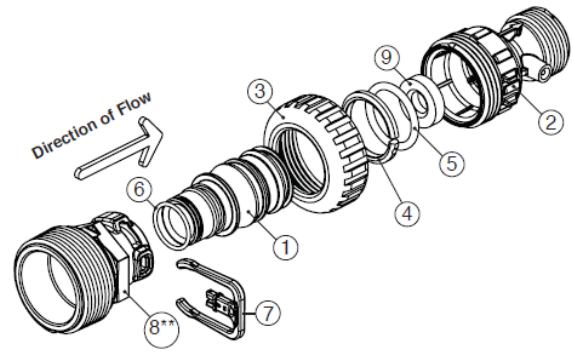

Item	Order No.	Description	Qty.
V3079		WS Drain Fitting, 1" Straight	
1	V3081	WS15 RETAINER DLFC ASY	1
2	V3645	WS15 DLFC FLANGE OUTLET FNPT	1
4	V3388	WS125 DLFC FLANGE INLET MNPT	1
5	V3652	BOLT HEXHD S/S HCS 5/16-18x3/4	4
6	V3441	O-RING 226	1
7	V3162-xx	See DLFC Section	0-6
8	V3190-xx	See DLFC Section	1

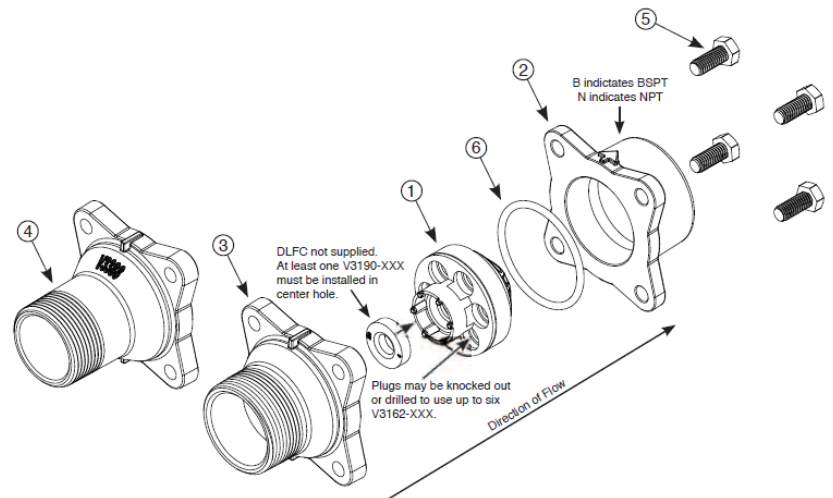
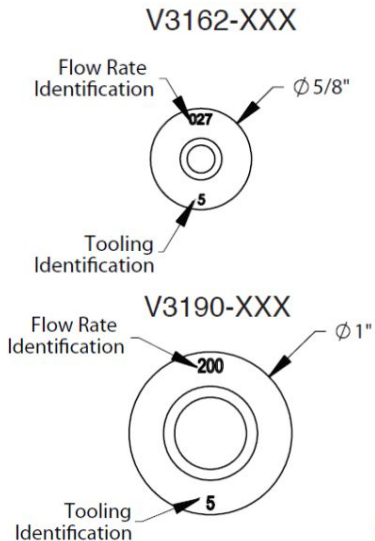

4.2.4) Outlet Meter Assembly

Note: Be sure the proper meter size is programmed in the software.

Standard meter cable used for spacing up to 3" between valve body and meter body, longer distance requires longer cable #V3221.

Service or replace the turbine by:

1. Turn the bypass for the system on and relieve the pressure on the system before removing the meter.
2. Press downward on the remote meter assembly to relieve tension on the retaining clip V3632.

Remove the clip and take the meter assembly out of the housing.

3. Remove the bend from the two exposed tips of the retaining clip V3501 and remove clip.
4. Service or replace the V3118-03 WS15/2 Turbine Assembly and place it back on the turbine shaft.
5. Insert the V3501 WS15/2 Turbine Clip and re-bend the exposed ends of the clip. The V3118-03 turbine has a groove to line up with the V3501 WS15/2 Turbine Clip.
6. Insert meter assembly back into the meter housing.
7. Re-install the meter retaining clip V3632 as shown below.

8. Open the bypass for the system slowly to bring back into service and check to be sure you have no water leaks.

The V3118-03 has a groove to line up with the V3501 WS1.5/2 Turbine Clip.

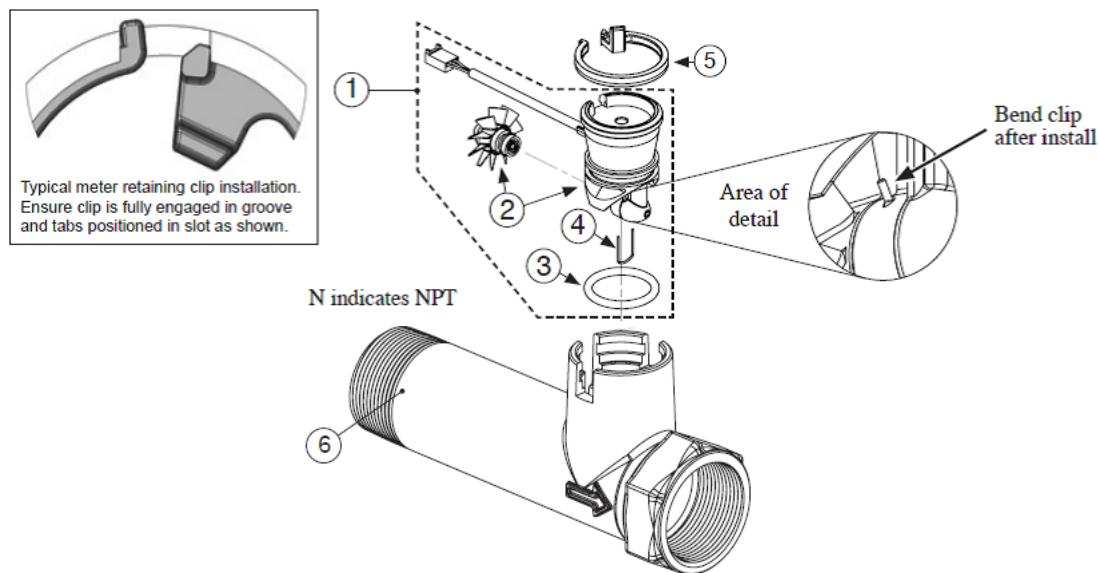

Drawing No.	Order No.	Description	Quantity
1	V3003-02	Commercial meter assembly, 28" Cable	1
	V3221	Commercial meter assembly, 15' Cable	
2	V3118-03	Commercial meter turbine assembly	1
3	V3105	O-ring, -215	1
4	V3501	Turbine clip	1
5	V3632 *	Meter Retaining Clip	1
6	V3401-04	WS1.5 Meter Housing NPT	1
Not Shown	V3437	WS1.5 Flow Straightener	1

V3040	1.5" NPT Meter, 28" Cable
V3040-15	1.5" NPT Meter, 15' Cable

5) NO HARD WATER BYPASS (NHWB)

Drawing No.	Order No.	Description	Quantity	
			V3097	V3097BSPT
1	V3073	MAV/NOHWBY COVER ASY	1	1
2	V3476	WS MOTOR ASY 8 FT	1	1
3	V3592	SCREW #8-1 PHPN T-25 SS	3	3
4	V3262-01	WS1.5&2ALT/2BY REDUCGEARCVASY	1	1
5	V3110-01	WS1 DRIVE REDUCING GEAR PLAIN	3	3
6	V3264	WS2 BYPASS REDUCTION GEAR AXLE	3	3
7	V3527	SCREW 1/4-20 X 3/4 BHSCS SS (5/32" HEX ALLEN WRENCH REQUIRED)	4	4
8	V3072	MAV/NOHWBY 1/125/15 DRIVE ASY	1	1
9	V3506-01	MAV/NOHRD 1/125/15 PISTON	1	1
10	V3886	WS15 NHWBY STACK ASY	1	1
11	V3832-01	WS15 NHWBY BODY M X F NPT	1	N/A
	V3832BSPT-01	WS15 NHWBY BODY M X F BSPT	N/A	1
Not Shown	V3805	STRAIN RELIEF COVER KIT	1	1

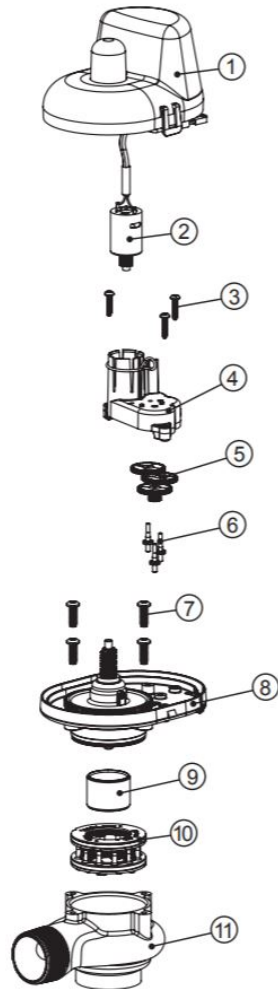

•Operating Pressures:
20 PSI Minimum / 125 PSI Maximum
•Operating Temperatures:
40°F Minimum / 110°F Maximum

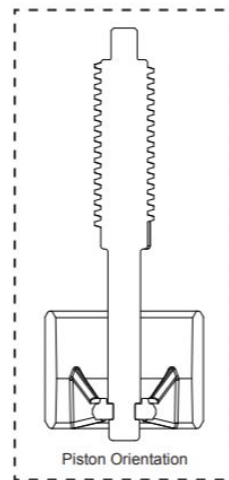

6) SERVICE INSTRUCTIONS

6.1) Front Cover Removal

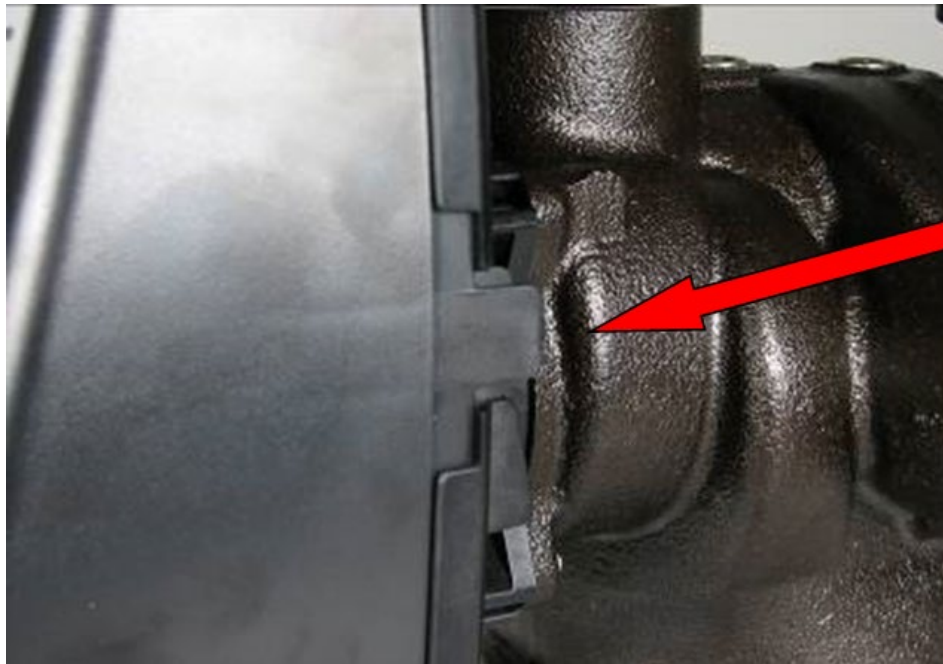

Pull out on each side of the covers locking tabs

6.2) PC Board Removal

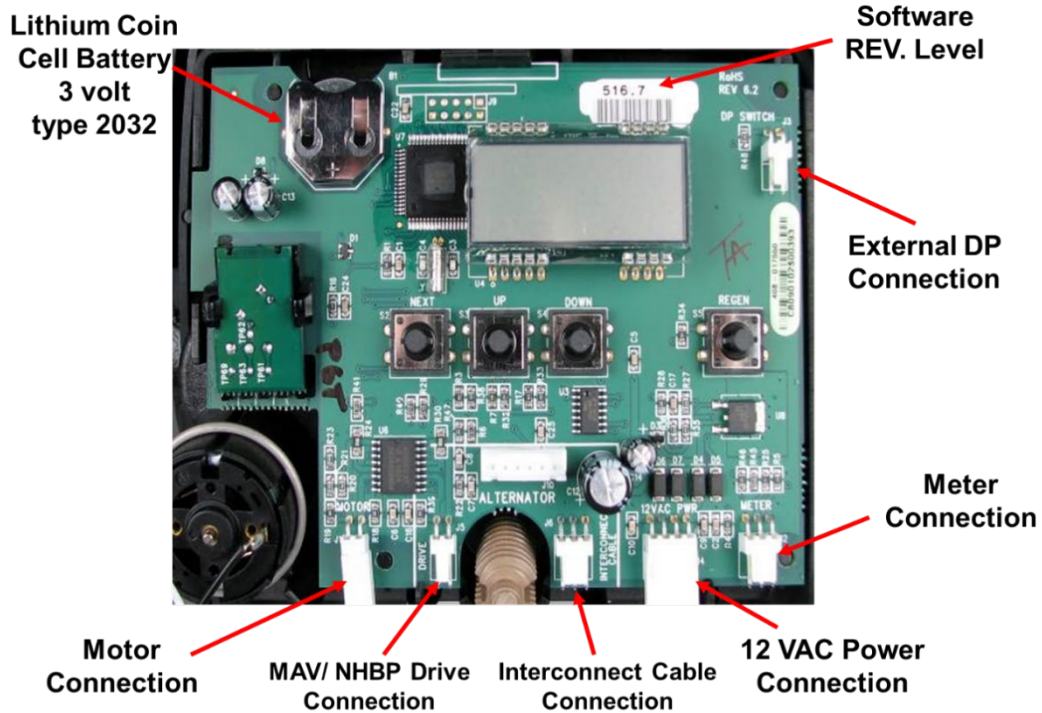

Disconnect the power cable first and then disconnect other cables.

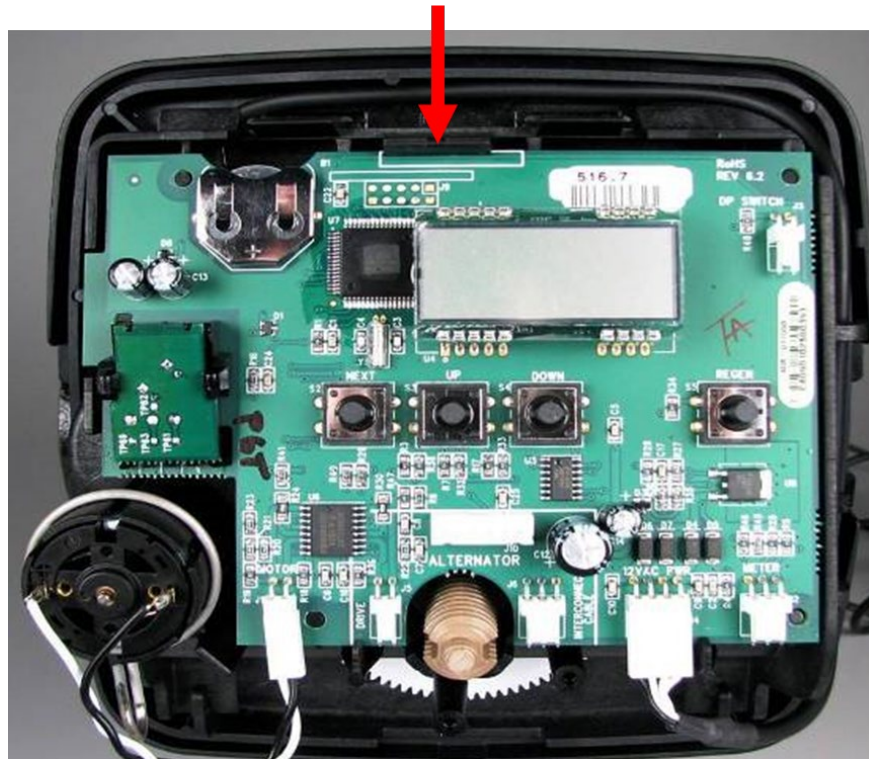

Lift up the locking tab and then pull out the PC board from top.

6.3) Drive Bracket Removal

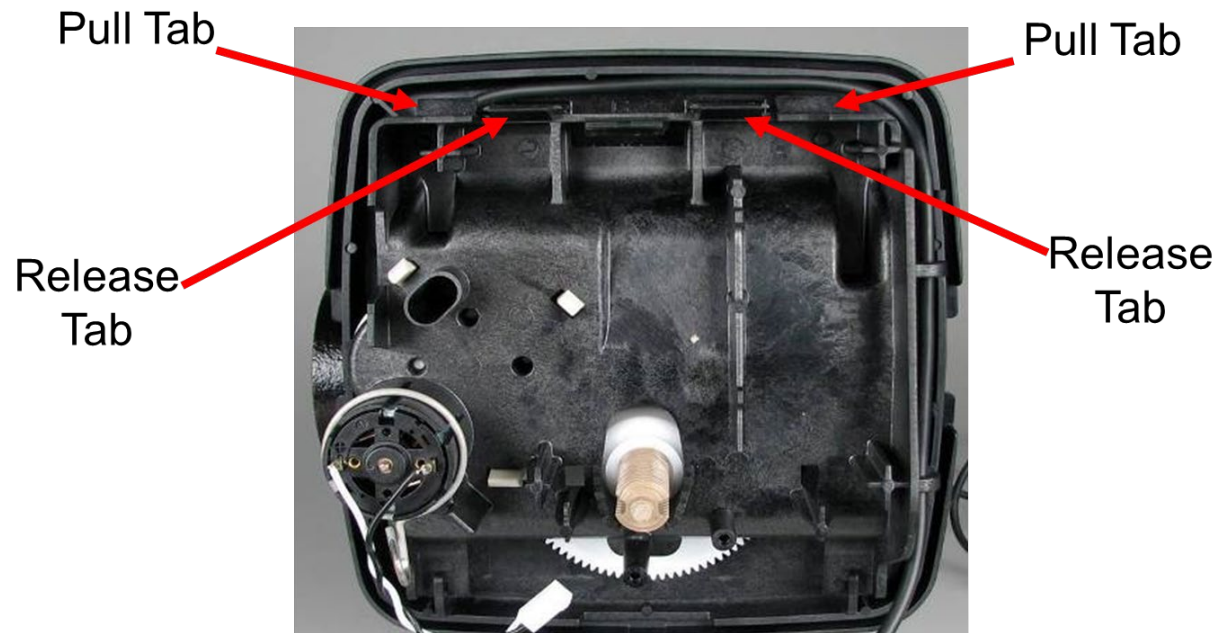

Lift up both locking tabs and pull out the bracket.

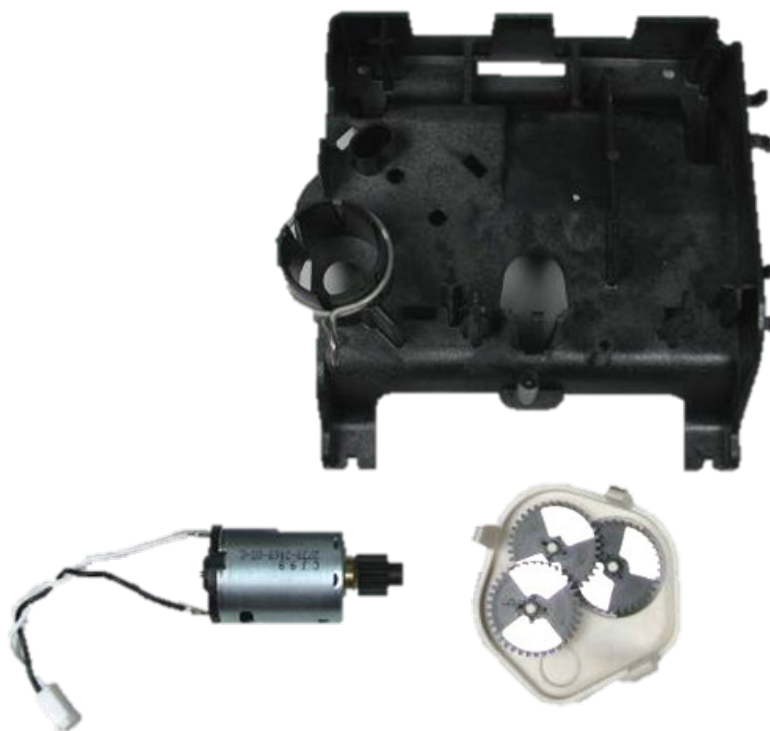

Motor can be removed by pressing the locking spring to the right and then pull the motor out. Gearbox can be removed by pushing the beige colored locking tabs inwards.

6.4) Drive Cap Removal



Turn the drive cap counter clockwise with the closed end of service wrench.



Pull out the drive cap with main piston.

6.5) Piston Removal



The main piston is attached with snap off connection.



Fully extend the piston by rotating white gear. Then put a side pressure in the direction of cavity to snap off the piston from rod.

6.6) Stack Assembly Removal



Stack assembly can be simply pulled out by hand from the control valve body.

6.7) Injector Cap Removal

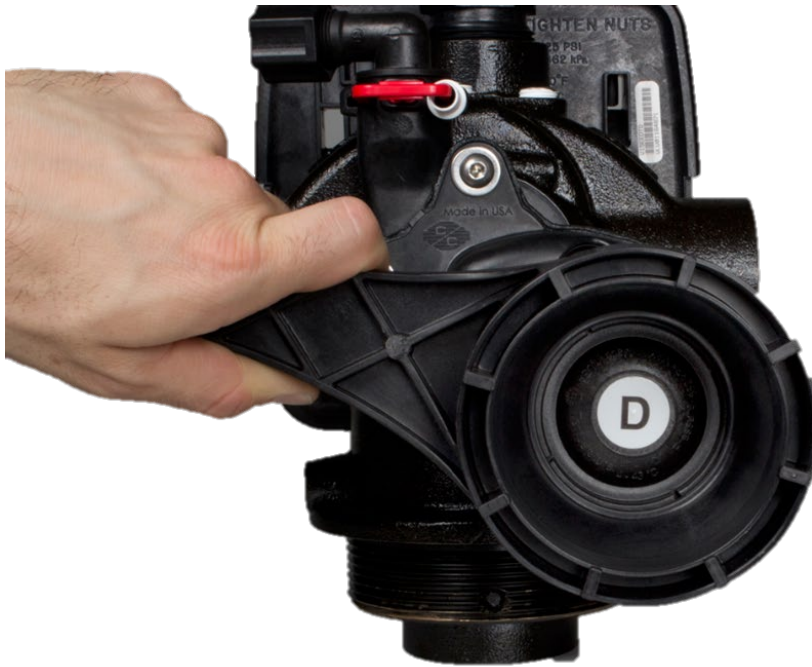

Turn injector cap counter clockwise with closed end of service wrench.



Gently pry the curled rim of injector with the bottom of injector cap to remove the injector.

7) TROUBLESHOOTING

7.1) Possible Error Codes

Possible Errors	
Code	Description
E1	Control unable to sense motor movement
Err-1001	
Err-101	
E2	Control Valve motor ran too short
Err-1002	
Err-102	
E3	Control Valve motor ran too long and unable to find next cycle
Err-1003	
Err-103	
Err-1004	Control Valve ran too long and timed out
Err-104	
Err-1006	MAV/NHWP motor ran too long
Err-106	
Err-1007	MAV/NHWP motor ran too short and stalled
Err-107	

7.2) Troubleshooting Procedures

Problem	Possible Cause	Solution
1. No Display on PC Board	a. No power at electric outlet	a. Repair outlet or use working outlet
	b. Control valve Power Adapter not plugged into outlet or power cord end not connected to PC board connection	b. Plug Power Adapter into outlet or connect power cord end to PC Board connection
	c. Improper power supply	c. Verify proper voltage is being delivered to PC Board
	d. Defective Power Adapter	d. Replace Power Adapter
	e. Defective PC Board	e. Replace PC Board
2. PC Board does not display correct time of day	a. Power Adapter plugged into electric outlet controlled by light switch	a. Use uninterrupted outlet
	b. Tripped breaker switch and/or tripped GFI	b. Reset breaker switch and/ or GFI switch
	c. Power outage	c. Reset time of day. If PC Board has battery back up present the battery may be depleted. See Front Cover and Drive Assembly drawing for instructions.
	d. Defective PC Board	d. Replace PC Board
3. Display does not indicate that water is flowing. Refer to user instructions for how the display indicates water is flowing	a. Bypass valve in bypass position	a. Turn bypass handles to place bypass in service position
	b. Meter is not connected to meter connection on PC Board	b. Connect meter to three pin connection labeled METER on PC Board
	c. Restricted/ stalled meter turbine	c. Remove meter and check for rotation or foreign material
	d. Meter wire not installed securely into three pin connector	d. Verify meter cable wires are installed securely into three pin connector labeled METER
	e. Defective meter	e. Replace meter
	f. Defective PC Board	f. Replace PC Board
4. Control valve regenerates at wrong time of day	a. Power outage	a. Reset time of day. If PC Board has battery back up present the battery may be depleted. See Front Cover and Drive Assembly drawing for instructions.
	b. Time of day not set correctly	b. Reset to correct time of day
	c. Time of regeneration set incorrectly	c. Reset regeneration time
	d. Control valve set at "on 0" (immediate regeneration)	d. Check programming setting and reset to NORMAL (for a delayed regen time)
	e. Control valve set at "NORMAL + on 0" (delayed and/ or immediate)	e. Check programming setting and reset to NORMAL (for a delayed regen time)
5. Time of day flashes on and off	a. Power outage	a. Reset time of day. If PC Board has battery back up present the battery may be depleted. See Front Cover and Drive Assembly drawing for instructions.
6. Control valve does not regenerate automatically when the REGEN button is depressed and held.	a. Broken drive gear or drive cap assembly	a. Replace drive gear or drive cap assembly
	b. Broken Piston Rod	b. Replace piston rod
	c. Defective PC Board	c. Defective PC Board
7. Control valve does not regenerate automatically but does when the REGEN button is depressed and held.	a. Bypass valve in bypass position	a. Turn bypass handles to place bypass in service position
	b. Meter is not connected to meter connection on PC Board	b. Connect meter to three pin connection labeled METER on PC Board
	c. Restricted/ stalled meter turbine	c. Remove meter and check for rotation or foreign material
	d. Incorrect programming	d. Check for programming error
	e. Meter wire not installed securely into three pin connector	e. Verify meter cable wires are installed securely into three pin connector labeled METER
	f. Defective meter	f. Replace meter
	g. Defective PC Board	g. Replace PC Board

FILTER INSTALLATION AND USER GUIDE

Problem	Possible Cause	Solution
8. Hard or untreated water is being delivered	a. Bypass valve is open or faulty	a. Fully close bypass valve or replace
	b. Media is exhausted due to high water usage	b. Check program settings or diagnostics for abnormal water usage
	c. Meter not registering	c. Remove meter and check for rotation or foreign material
	d. Water quality fluctuation	d. Test water and adjust program values accordingly
	e. No regenerant or low level of regenerant in regenerant tank	e. Add proper regenerant to tank
	f. Control fails to draw in regenerant	f. Refer to Trouble Shooting Guide number 12
	g. Insufficient regenerant level in regenerant tank	g. Check refill setting in programming. Check refill flow control for restrictions or debris and clean or replace
	h. Damaged seal/stack assembly	h. Replace seal/stack assembly
	i. Control valve body type and piston type mix matched	i. Verify proper control valve body type and piston type match
	j. Fouled media bed	j. Replace media bed
9. Control valve uses too much regenerant	a. Improper refill setting	a. Check refill setting
	b. Improper program settings	b. Check program setting to make sure they are specific to the water quality and application needs
	c. Control valve regenerates frequently	c. Check for leaking fixtures that may be exhausting capacity or system is undersized
10. Residual regenerant being delivered to service	a. Low water pressure	a. Check incoming water pressure – water pressure must remain at minimum of 25 psi
	b. Incorrect injector size	b. Replace injector with correct size for the application
	c. Restricted drain line	c. Check drain line for restrictions or debris and clean
11. Excessive water in regenerant tank	a. Improper program settings	a. Check refill setting
	b. Plugged injector	b. Remove injector and clean or replace
	c. Drive cap assembly not tightened in properly	c. Re-tighten the drive cap assembly
	d. Damaged seal/ stack assembly	d. Replace seal/ stack
	e. Restricted or kinked drain line	e. Check drain line for restrictions or debris and or un-kink drain line
	f. Plugged backwash flow controller	f. Remove backwash flow controller and clean or replace
	g. Missing refill flow controller	g. Replace refill flow controller
12. Control valve fails to draw in regenerant	a. Injector is plugged	a. Remove injector and clean or replace
	b. Faulty regenerant piston	b. Replace regenerant piston
	c. Regenerant line connection leak	c. Inspect regenerant line for air leak
	d. Drain line restriction or debris cause excess back pressure	d. Inspect drain line and clean to correct restriction
	e. Drain line too long or too high	e. Shorten length and or height
	f. Low water pressure	f. Check incoming water pressure – water pressure must remain at minimum of 25 psi
13. Water running to drain	a. Power outage during regeneration	a. Upon power being restored control will finish the remaining regeneration time. Reset time of day.
	b. Damaged seal/ stack assembly	b. Replace seal/ stack assembly
	c. Piston assembly failure	c. Replace piston assembly
	d. Drive cap assembly not tightened in properly	d. Re-tighten the drive cap assembly

FILTER INSTALLATION AND USER GUIDE

Problem	Possible Cause	Solution
14. E1, Err – 1001, Err – 101 = Control unable to sense motor movement	a. Motor not inserted full to engage pinion, motor wires broken or disconnected	a. Disconnect power, make sure motor is fully engaged, check for broken wires, make sure two pin connector on motor is connected to the two pin connection on the PC Board labeled MOTOR. Press NEXT and REGEN buttons for 3 seconds to resynchronize software with piston position or disconnect power supply from PC Board for 5 seconds and then reconnect.
	b. PC Board not properly snapped into drive bracket	b. Properly snap PC Board into drive bracket and then Press NEXT and REGEN buttons for 3 seconds to resynchronize software with piston position or disconnect power supply from PC Board for 5 seconds and then reconnect.
	c. Missing reduction gears	c. Replace missing gears
15. E2, Err – 1002, Err – 102 = Control valve motor ran too short and was unable to find the next cycle position and stalled	a. Foreign material is lodged in control valve	a. Open up control valve and pull out piston assembly and seal/ stack assembly for inspection. Press NEXT and REGEN buttons for 3 seconds to resynchronize software with piston position or disconnect power supply from PC Board for 5 seconds and then reconnect.
	b. Mechanical binding	b. Check piston and seal/ stack assembly, check reduction gears, check drive bracket and main drive gear interface. Press NEXT and REGEN buttons for 3 seconds to resynchronize software with piston position or disconnect power supply from PC Board for 5 seconds and then reconnect.
	c. Main drive gear too tight	c. Loosen main drive gear. Press NEXT and REGEN buttons for 3 seconds to resynchronize software with piston position or disconnect power supply from PC Board for 5 seconds and then reconnect.
	d. Improper voltage being delivered to PC Board	d. Verify that proper voltage is being supplied. Press NEXT and REGEN buttons for 3 seconds to resynchronize software with piston position or disconnect power supply from PC Board for 5 seconds and then reconnect.
16. E3, Err – 1003, Err – 103 = Control valve motor ran too long and was unable to find the next cycle position	a. Motor failure during a regeneration	a. Check motor connections then Press NEXT and REGEN buttons for 3 seconds to resynchronize software with piston position or disconnect power supply from PC Board for 5 seconds and then reconnect.
	b. Foreign matter built up on piston and stack assemblies creating friction and drag enough to time out motor	b. Replace piston and stack assemblies. Press NEXT and REGEN buttons for 3 seconds to resynchronize software with piston position or disconnect power supply from PC Board for 5 seconds and then reconnect.
	c. Drive bracket not snapped in properly and out enough that reduction gears and drive gear do not interface	c. Snap drive bracket in properly then Press NEXT and REGEN buttons for 3 seconds to resynchronize software with piston position or disconnect power supply from PC Board for 5 seconds and then reconnect.
17. Err – 1004, Err – 104 = Control valve motor ran too long and timed out trying to reach home position	a. Drive bracket not snapped in properly and out enough that reduction gears and drive gear do not interface	a. Snap drive bracket in properly then Press NEXT and REGEN buttons for 3 seconds to resynchronize software with piston position or disconnect power supply from PC Board for 5 seconds and then reconnect.

FILTER INSTALLATION AND USER GUIDE

Problem	Possible Cause	Solution
<p>18. Err -1006, Err – 106, Err - 116 = MAV/SEPS/ NHBP/ AUX MAV valve motor ran too long and unable to find the proper park position</p> <p>Motorized Alternating Valve = MAV</p> <p>Separate Source = SEPS</p> <p>No Hard Water Bypass = NHBP</p> <p>Auxiliary MAV = AUX MAV</p>	<p>a. Control valve programmed for ALT A or b, nHbP, SEPS, or AUX MAV without having a MAV or NHBP valve attached to operate that function</p>	<p>a. Press NEXT and REGEN buttons for 3 seconds to resynchronize software with piston position or disconnect power supply from PC Board for 5 seconds and then reconnect. Then re-program valve to proper setting.</p>
	<p>b. MAV/ NHBP motor wire not connected to PC Board</p>	<p>b. Connect MAV/ NHBP motor to PC Board two pin connection labeled DRIVE. Press NEXT and REGEN buttons for 3 seconds to resynchronize software with piston position or disconnect power supply from PC Board for 5 seconds and then reconnect.</p>
	<p>c. MAV/ NHBP motor not fully engaged with reduction gears</p>	<p>c. Properly insert motor into casing, do not force into casing Press NEXT and REGEN buttons for 3 seconds to resynchronize software with piston position or disconnect power supply from PC Board for 5 seconds and then reconnect.</p>
	<p>d. Foreign matter built up on piston and stack assemblies creating friction and drag enough to time out motor</p>	<p>d. Replace piston and stack assemblies. Press NEXT and REGEN buttons for 3 seconds to resynchronize software with piston position or disconnect power supply from PC Board for 5 seconds and then reconnect.</p>
<p>19. Err – 1007, Err – 107, Err - 117 = MAV/SEPS/ NHBP/ AUX MAV valve motor ran too short (stalled) while looking for proper park position</p> <p>Motorized Alternating Valve = MAV Separate</p> <p>Source = SEPS</p> <p>No Hard Water Bypass = NHBP</p> <p>Auxiliary MAV = AUX MAV</p>	<p>a. Foreign material is lodged in MAV/ NHBP valve</p>	<p>a. Open up MAV/ NHBP valve and check piston and seal/ stack assembly for foreign material. Press NEXT and REGEN buttons for 3 seconds to resynchronize software with piston position or disconnect power supply from PC Board for 5 seconds and then reconnect.</p>
	<p>b. Mechanical binding</p>	<p>b. Check piston and seal/ stack assembly, check reduction gears, drive gear interface, and check MAV/ NHBP black drive pinion on motor for being jammed into motor body. Press NEXT and REGEN buttons for 3 seconds to resynchronize software with piston position or disconnect power supply from PC Board for 5 seconds and then reconnect.</p>

8) 5 YEAR WARRANTY

Commercial Progressive Water Filter

Thank you for your purchase of our COMMERCIAL PROGRESSIVE WATER FILTER. For proof of purchase, please retain your Invoice/Sales Order Copy.

Warranty ~ Offered

Excalibur Water Systems warrants its products to be free from defect in materials and workmanship to the original owner from the date on the proof of purchase as described below.

Warranty ~ Working Procedures

If during the suitable warranty period, a part is defective, then Excalibur Water Systems will repair or replace that part at no charge to the original owner, with the exception of charges for nominal shipping, service and/or installation.

Warranty ~ Coverage Outlined

Excalibur Water Systems guarantees, to the original owner, a period of 5 years, the CONTROL BODY to be free of defects in materials and workmanship and to perform its proper functions. To the original owner, a period of 5 years, the ELECTRONIC CONTROL VALVES as well as all parts to be free of defects in materials and workmanship and to perform their normal functions. To the original owner, the MINERAL TANKS will not rust, corrode, leak, burst or in any other form fail to perform their proper functions for a period of 10 YEARS.

Warranty ~ Service

In the event you require service, Excalibur Water Systems Dealer will provide all necessary service and installation for your Duplex Commercial Water Filter. To obtain warranty service within 30 days of discovery of the defect, notification must be given to Excalibur Water Systems.

General Provisions

The above warranties are effective provided the WATER FILTER is operated at water pressures not exceeding 125psi and at water temperatures not exceeding 120°F; also provided that the water filter is not subject to abuse, misuse, alteration, neglect, freezing, accident or negligence; and provided further that the water filter is not damaged as the result of any unusual force of nature such as, but not limited to flood, hurricane, tornado or earthquake. Excalibur Water Systems is excused if failure to perform its warranty obligations is the result of strikes, government regulation, materials shortages or other circumstances beyond its control.

THERE ARE NO WARRANTIES ON THE WATER FILTER BEYOND THOSE SPECIFICALLY DESCRIBED ABOVE. ALL IMPLIED WARRANTIES, INCLUDING ANY IMPLIED WARRANTY OF MERCHANTABILITY OR OF FITNESS FOR A PARTICULAR PURPOSE, ARE DISCLAIMED TO THE EXTENT THEY MIGHT EXTEND BEYOND THE ABOVE PERIODS. THE SOLE OBLIGATION OF EXCALIBUR WATER SYSTEMS UNDER THESE WARRANTIES IS TO REPLACE OR REPAIR THE COMPONENT OR PART PROVES TO BE DEFECTIVE WITHIN THE SPECIFIED TIME PERIOD AND EXCALIBUR WATER SYSTEMS IS NOT LIABLE FOR CONSEQUENTIAL OR INCIDENTAL DAMAGES. NO DEALER, AGENT, REPRESENTATIVE OR OTHER PERSON IS AUTHORIZED TO EXTEND OR EXPAND THE WARRANTIES EXPRESSED ABOVE.

Certain provinces or states do not allow limitations on how long an implied warranty lasts or exclusions or limitations of incidental or consequential damage, therefore limitations and exclusions in this warranty may not apply to you. This warranty extends you specific legal rights as you may have other rights which vary from province to province or state to state.

Excalibur Water Systems is a manufacturer of water treatment products.

142 Commerce Park Drive

Barrie, Ontario Canada

